



# MPPT Solar Charge Controller

## User Manual

---



### Models:

TRIRON1206N/TRIRON1210N

TRIRON2206N/TRIRON2210N

TRIRON3210N/TRIRON3215N

TRIRON4210N/TRIRON4215N

# Important Safety Instructions

## Please save this manual for future review.

This manual contains safety, installation, and operation instructions for the Maximum Power Point Tracking (MPPT) TRIRON series controller ("the controller" as referred to in this manual).

### **General Safety Information**

- Read all the instructions and warnings carefully in the manual before installation.
- No user-serviceable components exist inside the controller. DO NOT disassemble or attempt to repair the controller.
- Mount the controller indoors. Prevent exposure to the elements and do not allow water to enter the controller.
- Install the controller in a well-ventilated -place. The controller's heat sink may become very hot during operation.
- It is suggested to install appropriate external fuses/breakers.
- Disconnect all PV array connections and the battery fuse/breakers before controller installation and adjustment.
- Power connections must remain tight to avoid excessive heating from a loose connection.

# CONTENTS

<b>1 General Information</b>	<b>1</b>
1.1 Overview	1
1.2 Characteristics	2
1.3 Module Types	3
1.4 Naming rules	6
<b>2 Installation</b>	<b>7</b>
2.1 Attentions	7
2.2 PV Array Requirements	7
2.3 Wire Size	9
2.4 Mounting	10
<b>3 Modules installation</b>	<b>14</b>
<b>4 Module Introduction</b>	<b>16</b>
4.1 Display Module	16
4.1.1 Display Basic1 (DB1)	16
4.1.2 Display Standard1 (DS1)	17
4.1.3 Display Standard 2 (DS2)	21
4.2 Interface Modules	26
4.2.1 Interface type	26
4.2.2 Double USB (USB1)	27
4.2.3 USB COM Slave (UCS)	27
4.2.4 Relay COM Master (RCM connects EPEVER inverter only)	28
4.2.5 Relay COM Slave (RCS connects the accessories)	29

<b>5 Parameters Setting</b>	<b>30</b>
5.1 Battery parameters	30
5.1.1 Supported battery types	30
5.1.2 Local setting	30
5.1.3 Remote Setting	34
5.2 Load working modes	37
5.2.1 LCD setting	37
5.2.2 RS485 communication setting	38
<b>6 Others</b>	<b>40</b>
6.1 Protection	40
6.2 Troubleshooting	41
6.3 Maintenance	44
<b>7 Technical Specifications</b>	<b>45</b>
<b>Annex I Conversion Efficiency Curves</b>	<b>47</b>

# 1 General Information

## 1.1 Overview

The TRIRON series controllers are modular-designed products based on six MPPT solar controller models. The main unit(Power Module)(TRIRON\*\*\*\*N) is a solar controller that can be integrated with different display and interface modules to meet various functional requirements. The TRIRON series controllers can automatically identify and load the drivers of various modules. There are three display modules (Basic 1(DB1), Standard1(DS1), and Standard2(DS2)) and four interface modules (USB COM Slave(UCS), Relay COM Slave(RCS), Relay COM Master(RCM), and Dual USB1(USB1)). Users can choose any combination of these modules according to their needs.

The controllers can track the PV maximum power point, minimize the maximum power point loss rate and time, and obtain the maximum energy under any conditions. They can increase the solar system's energy utilization ratio by 20%-30% compared with a PWM charging method. With the three-stage charging mode, the TRIRON series controllers can prolong the battery's lifecycle, improve the system performance, and support electronic protection functions. The overcharging and over-discharging protections minimize damages to components caused by incorrect installation or system failure at the utmost. Ensure safer and more reliable solar power supply system operation for a longer service time. This modular solar controller can be widely used for different applications, e.g., communication base stations, household systems, street lighting systems, field monitoring, etc.

### Features:

- Identify and load the drivers of various modules automatically
- Modular design for easy combination and replacement
- Advanced MPPT control algorithm to minimize the MPP loss rate and loss time
- Advanced MPPT technology, with efficiency no less than 99.5%.
- Maximum DC/DC conversion efficiency of 98%
- Ultra-fast tracking speed and guaranteed tracking efficiency.
- Automatic limitation of the charging power and current
- Wide MPP operating voltage range.
- Multiple load work modes
- Support the lead-acid and lithium batteries; voltage parameters can be set on the controller<sup>①</sup>
- Programmable temperature compensation
- Real-time energy statistics function.
- Overheating power reduction function

- LCD and indicators to display operating data and the system status
- User-friendly buttons for comfortable and convenient operation
- Master and slave RS485 communication modules design, reading the load or inverter operating data
- Control the inverter switch through the relay interface
- Provide 5VDC power through the dual USB output interface to charge electronic devices

① For the BCV, FCV, LVD, and LVR, users can modify them on the local controller when the battery type is "USE."

## 1.2 Characteristics

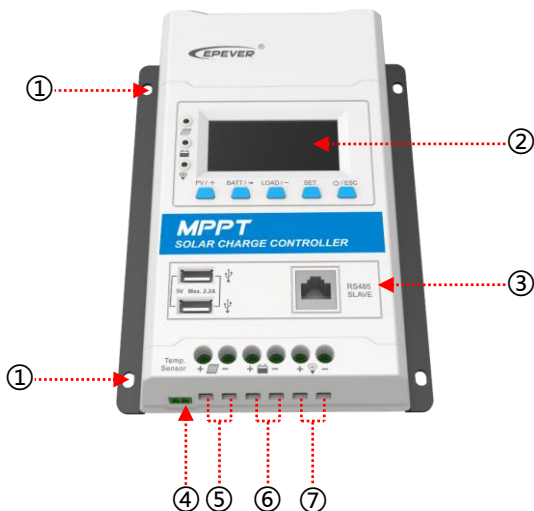

Figure 1 Product Characteristics

①	Mounting Hole $\Phi 5\text{mm}$	⑤	PV Terminals
②	Display Module	⑥	Battery Terminals
③	Interface Module	⑦	Load Terminals
④	RTS* Interface		
<p>※ If the temperature sensor is short-circuited or damaged, the controller will charge or discharge at the default temperature setting of 25 °C.</p>			

## 1.3 Module Types

### ➤ 1-Power Modules



The Power Modules control PV battery charging & load discharging without any display or interface modules installed –they can operate independently. Suppose a display or interface module is installed. In that case, it will be powered by the Power module, and the appropriate module driver will be loaded.

**NOTE: The power module can be operated independently without any other modules.**

Model	System voltage	Max. PV open circuit voltage	Rated charge/discharge current	Picture
TRIRON1206N	12/24VDC	60V	10A	
TRIRON2206N	12/24VDC	60V	20A	
TRIRON1210N	12/24VDC	100V	10A	
TRIRON2210N	12/24VDC	100V	20A	
TRIRON3210N	12/24VDC	100V	30A	
TRIRON4210N	12/24VDC	100V	40A	
TRIRON3215N	12/24VDC	150V	30A	
TRIRON4215N	12/24VDC	150V	40A	

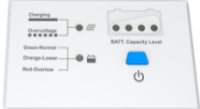

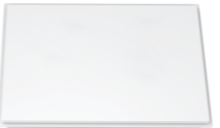

### ➤ 2-Display Modules

Module	Description	Picture
Display Basic1	<b>LED Indicators:</b> PV & battery working status <b>Button:</b> When the working mode is Manual Control, the load is ON/OFF via the button.	

<p>Display Standard 1</p>	<p>DS1</p>	<p><b>LED Indicators:</b> PV &amp; load working status  <b>Buttons:</b> View or set the parameters  <b>LCD:</b> <i>PV display:</i> voltage/current /generated energy  <b>Battery display:</b> voltage/current/temperature  <b>Load:</b></p> <ul style="list-style-type: none"> <li>• Display current/load working mode when the controller communicates with the <b>PC or APP.</b></li> <li>• Display voltage/current/ power consumption when the controller communicates with <b>the inverter.</b></li> </ul>	
<p>Display Standard 2</p>	<p>DS2</p>	<p><b>Indicators:</b> PV &amp; battery &amp; load working status  <b>Buttons:</b> View or set the parameters  <b>LCD:</b> <i>PV display</i> voltage/current /generated energy/Power  <i>Battery display</i> voltage/ current/temperature/capacity  <b>Load:</b></p> <ul style="list-style-type: none"> <li>• Display voltage/ current/ power/ load working mode when the controller communicates with the <b>PC or APP.</b></li> <li>• Display voltage/current/power consumption when the controller communicates with <b>the inverter.</b></li> </ul>	
<p>No Display Cover</p>	<p>DCV</p>	<p>No indicator or display</p>	

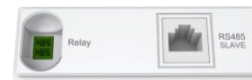

➤ Interface Modules

Module		Function	Picture
USB COM Slave	UCS	<p><b><u>RS485 interface:</u></b> Connect to PC or phone. View or change the controller parameters.</p> <p><b><u>USB interface:</u></b> Supplies 5VDC for electronic equipment. <b>NOTE: The USB interface is output when the load is ON.</b></p>	
Relay COM Master	RCM	<p><b><u>RS485 interface:</u></b> Connect to the inverter. View the inverter parameters via the LCD.</p> <p><b><u>Relay interface:</u></b> Remotely control the inverter ON/OFF. <b>NOTE: The module can't connect the accessories.</b></p>	 <p><b>Accessory: 3.81-2P terminal</b></p>
Relay COM Slave	RCS	<p><b><u>RS485 interface:</u></b> Connect to PC or phone. View or change the controller parameters.</p> <p><b><u>Relay interface:</u></b> Remotely control the inverter ON/OFF. <b>NOTE: The module can connect the accessories.</b></p>	 <p><b>Accessory: 3.81-2P terminal</b></p>
Double USB	USB1	<p><b><u>USB interface:</u></b> Supplies 5VDC for electronic equipment. <b>NOTE: The USB interface is output when the load is ON.</b></p>	

No COM Cover	CCV	No interface	
-----------------	-----	--------------	---

 <b>CAUTION</b>	The controller must be powered off for 1 minute when the user replaces the display modules or interface modules.
---	--

## 1.4 Naming rules

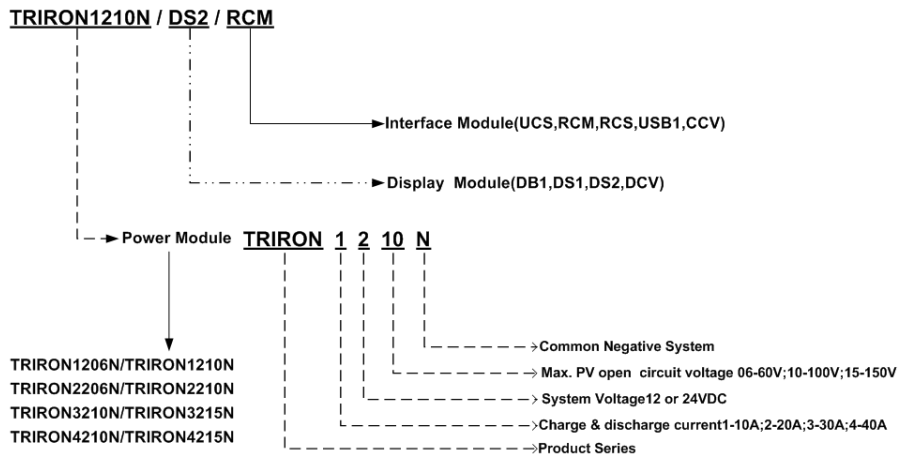

## 2 Installation

### 2.1 Attentions

- Please read the instructions to familiarize yourself with the installation steps before installation.
- Be very careful when installing the batteries, especially flooded lead-acid batteries. Please wear eye protection, and have fresh water available to wash and clean any contact with battery acid.
- Keep the battery away from any metal objects, which may cause a short circuit of the battery.
- Explosive battery gases may come out from the battery during charging, so make sure the ventilation condition is good.
- Ventilation is highly recommended if mounted in an enclosure. Never install the controller in a sealed enclosure with flooded batteries! Battery fumes from vented batteries will corrode and destroy the controller circuits.
- Loose power connections and corroded wires may produce high heat that can melt wire insulation, burn surrounding materials, or even cause a fire. Ensure tight connections, use cable clamps to secure cables, and prevent them from swaying in mobile applications.
- Lead-acid and lithium batteries are recommended, other kinds, please refer to the battery manufacturer.
- The battery connection may be wired to one battery or a bank of batteries. The following instructions refer to a singular battery. However, it is implied that the battery connection can be made to either one battery or a group of batteries in a battery bank.
- Multiple models of controllers can be installed in parallel on the same battery bank to achieve a higher charging current. Each controller must have its solar module(s).
- Select the system cables according to  $5A/mm^2$  or less current density following Article 690 of the National Electrical Code, NFPA 70.

### 2.2 PV Array Requirements

#### Serial connection (string) of PV modules

As the core component of the PV system, the controller could be suitable for various types of PV modules and maximize converting solar energy into electrical energy. The series number of different PV modules can be calculated according to the open-circuit voltage (Voc) and the maximum power point voltage (VMpp) of the MPPT controller. The below table is for reference only.

**TRIRON1206N/2206N:**

System voltage	36 cell Voc<23V		48 cell Voc <31V		54 cell Voc<34V		60 cell Voc<38V	
	Max.	Best	Max.	Best	Max.	Best	Max.	Best
12V	2	2	1	1	1	1	1	1
24V	2	2	-	-	-	-	-	-

System voltage	72 cell Voc<46V		96 cell Voc<62V		Thin-Film Module Voc>80V
	Max.	Best	Max.	Best	
12V	1	1	-	-	-
24V	1	1	-	-	-

**NOTE:** The above parameter values are calculated under standard test conditions (STC (Standard Test Condition): Irradiance 1000W/m<sup>2</sup>, Module Temperature 25°C, Air Mass1.5.)

**TRIRON1210N/2210N/3210N/4210N:**

System voltage	36 cell Voc<23V		48 cell Voc<31V		54 cell Voc<34V		60 cell Voc<38V	
	Max.	Best	Max.	Best	Max.	Best	Max.	Best
12V	4	2	2	1	2	1	2	1
24V	4	3	2	2	2	2	2	2

System voltage	72 cell Voc<46V		96 cell Voc<62V		Thin-Film Module Voc>80V
	Max.	Best	Max.	Best	
12V	2	1	1	1	1
24V	2	1	1	1	1

**NOTE:** The above parameter values are calculated under standard test conditions (STC (Standard Test Condition): Irradiance 1000W/m<sup>2</sup>, Module Temperature 25°C, Air Mass1.5.)

**TRIRON3215/4215N:**

System voltage	36cell Voc<23V		48cell Voc<31V		54cell Voc<34V		60cell Voc<38V	
	Max.	Best	Max.	Best	Max.	Best	Max.	Best
12V	4	2	2	1	2	1	2	1
24V	6	3	4	2	4	2	3	2

System voltage	72cell Voc<46V		96cell Voc<62V		Thin-Film Module Voc>80V
	Max.	Best	Max.	Best	
12V	2	1	1	1	1
24V	3	2	2	1	1

**NOTE:** The above parameter values are calculated under standard test conditions (STC (Standard Test Condition): Irradiance 1000W/m<sup>2</sup>, Module Temperature 25°C, Air Mass1.5.)

## 2.3 Wire Size

The wiring and installation methods must conform to national and local electrical code requirements.

### ➤ PV Wire Size

The PV array output varies with the PV module size, connection method, or sunlight angle. The PV array I<sub>sc</sub>\* can calculate the minimum wire size. Please refer to the value of I<sub>sc</sub> in the PV module specification. When PV modules are connected in series, the I<sub>sc</sub> equals a PV modules I<sub>sc</sub>. When PV modules are connected in parallel, the I<sub>sc</sub> equals the sum of the PV module's I<sub>sc</sub>. The I<sub>sc</sub> of the PV array must not exceed the controller's maximum PV input current. Please refer to the table below:

**NOTE: All PV modules in a given array are assumed to be identical.**

**\* I<sub>sc</sub>=short circuit current(amps) Voc=open circuit voltage.**

Model	Max. PV input current	Max. PV wire size*
TRIRON1206N TRIRON1210N	10A	4mm <sup>2</sup> /12AWG
TRIRON2206N TRIRON2210N	20A	6mm <sup>2</sup> /10AWG
TRIRON3210N TRIRON3215N	30A	10mm <sup>2</sup> /8AWG
TRIRON4210N TRIRON4215N	40A	16mm <sup>2</sup> /6AWG

**\* These are the maximum wire sizes that will fit the controller terminals.**

 <b>CAUTION</b>	<p>When the PV modules are connected in series, the open-circuit voltage of the PV array must not exceed 46V (TRIRON**06N), 92V (TRIRON**10N), or 92V (TRIRON**15N) at 25°C environment temperature.</p>
---	--



### ➤ Battery and Load Wire Size

The battery and load wire size must conform to the rated current. The reference size is as below:

Model	Rated charge current	Rated discharge current	Battery wire size	Load wire size
TRIRON1206N TRIRON1210N	10A	10A	4mm <sup>2</sup> /12AWG	4mm <sup>2</sup> /12AWG
TRIRON2206N TRIRON2210N	20A	20A	6mm <sup>2</sup> /10AWG	6mm <sup>2</sup> /10AWG
TRIRON3210N TRIRON3215N	30A	30A	10mm <sup>2</sup> /8AWG	10mm <sup>2</sup> /8AWG
TRIRON4210N TRIRON4215N	40A	40A	16mm <sup>2</sup> /6AWG	16mm <sup>2</sup> /6AWG

 <b>CAUTION</b>	The wire size is only for reference. Suppose there is a long distance between the PV array, the controller, and the battery. In that case, larger wires can be used to reduce the voltage drop and improve performance.
---	---

## 2.4 Mounting

 <b>WARNING</b>	<ul style="list-style-type: none"><li>• Risk of explosion! Never install the controller in a sealed enclosure with flooded batteries! Do not install in a confined area where battery gas can accumulate.</li><li>• Risk of electric shock! When wiring the solar modules, the PV array can produce open-circuit voltages over 100V in sunlight.</li></ul>
 <b>CAUTION</b>	The controller requires at least 150mm of clearance above and below for proper airflow. Ventilation is highly recommended if mounted in an enclosure.

## Installation Procedure:

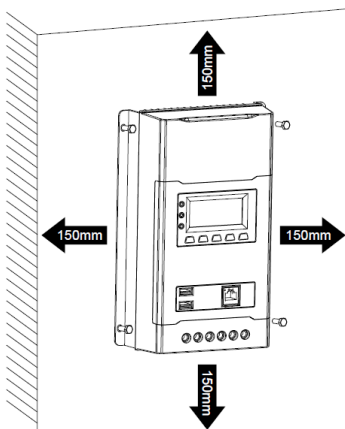

Figure 2-1 Mounting

### Step 1: Determination of the installation location and heat-dissipation Space

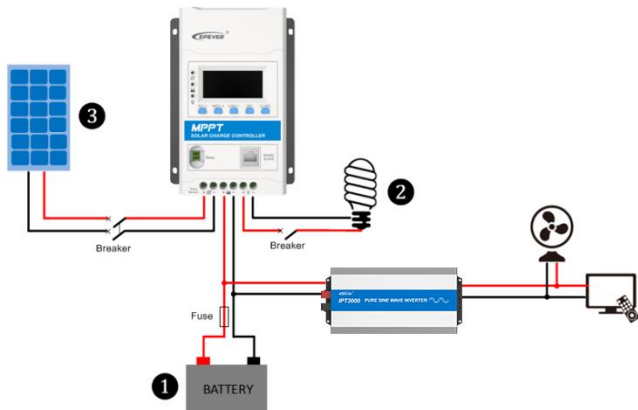





Figure 2-2 Schematic of wiring diagram

The controller shall be installed in a place with sufficient airflow through the controller radiators and a minimum clearance of 150 mm from the upper and lower edges of the controller to ensure natural thermal convection. Please see Figure 2-1: Mounting.



Suppose the controller is to be installed in an enclosed box. In that case,

<b>CAUTION</b>	ensuring reliable heat dissipation through the box is important.
----------------	--

**Step 2:** Connect the system in the order of ① battery  → ② load  → ③ PV array  by Figure 2-2, "Schematic Wiring Diagram" and disconnect the system in the reverse order ③ ② ①.

 <b>CAUTION</b>	<ul style="list-style-type: none"> <li>• While wiring the controller, do NOT connect the circuit breaker or fuse and ensure that the electrode polarity is correctly connected.</li> <li>• A fuse whose current is 1.25 to 2 times the rated current of the controller must be installed on the battery side with a distance from the battery not greater than 150 mm.</li> <li>• Suppose an inverter is to be connected to the system. In that case, you must connect the inverter directly to the battery, not to the load side of the controller.</li> </ul>
---	---

### Step 3: Grounding

As the TRIRON series is a common negative controller, the negative poles of the PV array, battery and load can be grounded together.

 <b>CAUTION</b>	The controller can also be used in a common positive system. In this case, the negative poles of the controller, PV, and load can't be grounded together, but only one of them can be grounded.
---	---

### Step 4: Connect accessories

- **Connect the remote temperature sensor cable (model: RTS300R47K3.81A)**

Connect one end of the remote temperature sensor cable to the interface ③ and place the other end close to the battery.

 <b>CAUTION</b>	Suppose the remote temperature sensor is not connected to the controller. In that case, the default battery charging or discharging temperature setting is 25°C without temperature compensation.
---	---

- **Connect the accessories for RS485 communication**

Refer to 3.2 "Setting and Operation of Controller."

 <b>CAUTION</b>	The RS485 port is designed without isolation, and it is recommended to connect an RS485 communication isolator at the interface for communication.
---	--



### Step 5: Powered on the controller

Connect the battery fuse to power the controller. Then check the battery indicator's status (the controller operates normally when the indicator is lit in green). Connect the fuse and circuit breaker of the load and PV array. Then the system will work in preprogrammed mode.



**CAUTION**

If the controller is not operating properly or the battery indicator on the controller shows an abnormality, please refer to 4.2 "Troubleshooting."

### 3 Modules installation

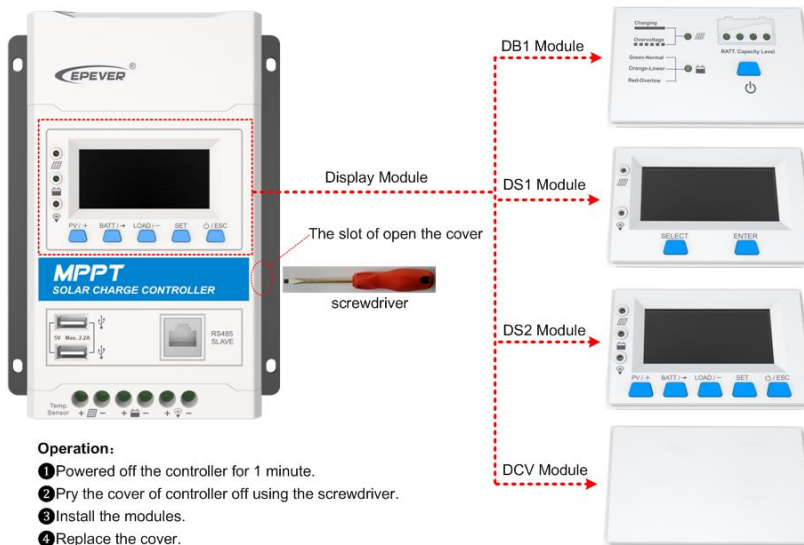

#### Operation:

- 1 Powered off the controller for 1 minute.
- 2 Pry the cover of controller off using the screwdriver.
- 3 Install the modules.
- 4 Replace the cover.
- 5 Power on the controller.

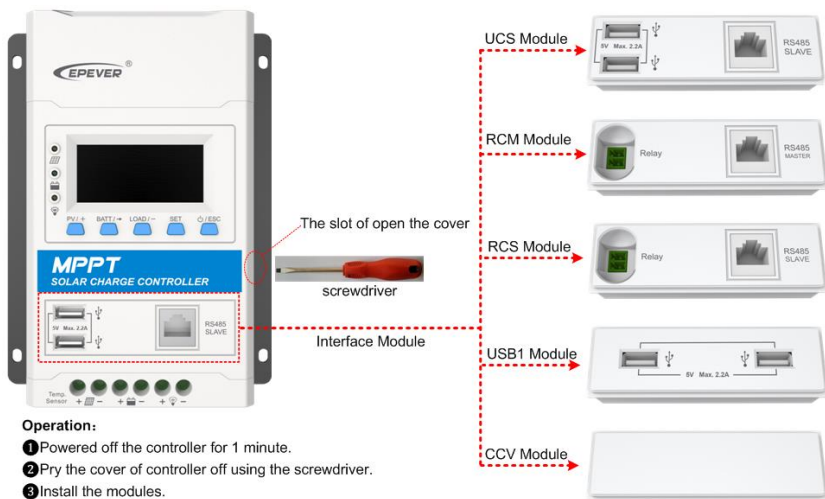

**Operation:**

- ① Powered off the controller for 1 minute.
- ② Pry the cover of controller off using the screwdriver.
- ③ Install the modules.
- ④ Replace the cover.
- ⑤ Power on the controller.



# 4 Module Introduction

## 4.1 Display Module

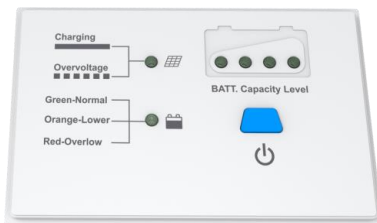
### 4.1.1 Display Basic1 (DB1)



#### (1) Charging and battery LED indicator

Indicator	Color	Status	Information
	Green	On Solid	PV charges the battery with a low current
	Green	OFF	1. No sunlight 2. Connection error 3. Low PV voltage
	Green	Slowly flashing(1Hz)	Normal charging
	Green	Fast flashing(4Hz)	PV Over voltage
	Green	On Solid	Normal
	Green	Slowly flashing(1Hz)	Full
	Green	Fast flashing(4Hz)	Over voltage
	Orange	On Solid	Under voltage
	Red	On Solid	Over discharged
	Red	Slowly flashing(1Hz)	Battery Overheating Low temperature <sup>①</sup>
All LED indicators fast flashing at the same time			System voltage error <sup>②</sup> Controller Overheating

① When a lead-acid battery is used, the controller doesn't have low-temperature protection.

② When a lithium-ion battery is used, the system voltage can't be identified automatically.

#### (2) Battery Capacity Level Indicator

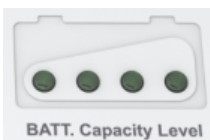

- Battery Capacity Level (BCL)**

Indicator	Color	Status	Information
☆○○○	Green	25% indicators slowly flashing	0%to <25%
●☆○○	Green	50% indicators slowly flashing 25% indicators are ON	25%to <50%
●●☆○	Green	75% indicators slowly flashing 25%,50% indicators are ON	50%to <75%
●●●☆	Green	100% indicators slowly flashing 25%,50%,75% indicators are ON	75% to 100%
●●●●	Green	25%,50%,75%,100% indicators are ON	100%

"○" Indicator is OFF; "●" Indicator is on Solid; "☆" Indicator is slowly flashing.

- Load status**

Battery Capacity Level	Green	on solid	The load is ON
	Green	OFF	The load is OFF



### (3) Button

In the manual mode of the load, it can control the On/Off of the load via the  button.







## 4.1.2 Display Standard1 (DS1)



### (1) Indicator

Indicator	Color	Status	Instruction
	Green	On Solid	PV charges the battery with a low current
	Green	OFF	1. No sunlight 2. Connection error 3. Low PV voltage
	Green	Slowly Flashing(1Hz)	Normal charging
	Green	Fast Flashing(4Hz)	PV Over voltage
	Red	On Solid	Load ON
	Red	OFF	Load OFF

## (2) Button



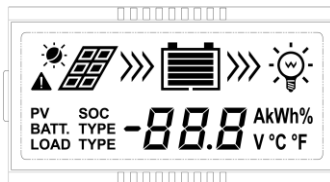

Mode	Note
Load ON/OFF	In manual load mode, it can turn the load On/Off of the load via the  button.
Clear Fault	Press the  button
Browsing Mode	Press the  button
Setting Mode	Press the  button and hold on 5s to enter the setting mode Press the  button to set the parameters, Press the  button to confirm the setting parameters or exit the setting mode automatically after 10s.



## (3) Interface



**Note:** The display screen can be viewed clearly when the angle between the end-users horizontal sight and the display screen is within 90°. If the angle exceeds 90°, the information on the display screen cannot be viewed clearly.

### 1) Icon

Item	Icon	Status
PV array		Day
		Night
		No charging
		Charging
	<b>PV</b>	PV Voltage, Current, Power
Battery		Battery capacity, In Charging
	<b>BATT.</b>	Battery Voltage, Current, Temperature
	<b>BATT. TYPE</b>	Battery Type

Load		Load ON
		Load OFF
	<b>LOAD</b>	Load Voltage, Current, Load mode

## 2) Browse interface

Press the  button to cycle display the following interfaces.

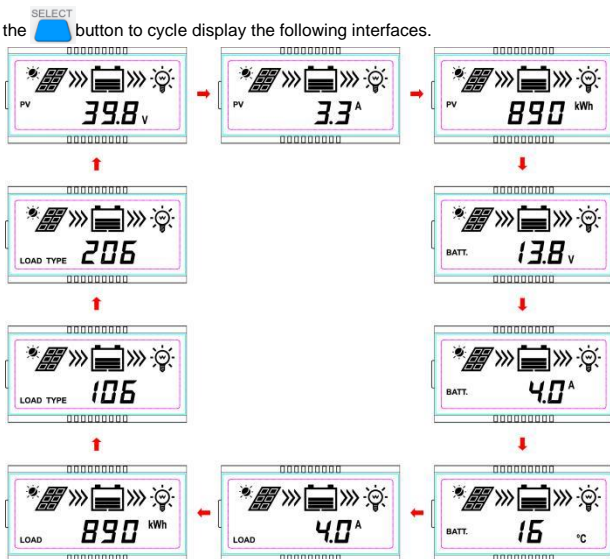

## 3) Load parameters

- **Combination of the DS1 and RCM modules (To connect the system with the inverter, refer to 4.2.4)**

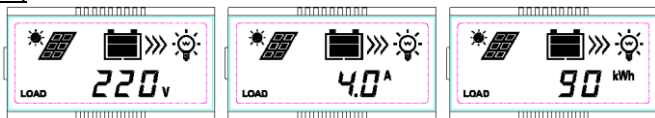

Display: Voltage/Current/Consumed power

- **Combination of the DS2 and UCS modules with the LCD (connect a LED load: refer to 4.2.5)**

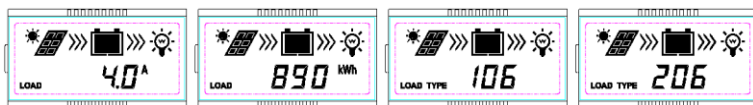



Display: Current/Consumed power/Load working mode-Timer1/ Load working mode-Timer2

#### 4) Setting

##### ① Clear the generated energy

Operating:

**Step 1:** Long-press the  button under the PV power interface until the value flashes.

**Step 2:** Press the  button to clear the generated energy.

##### ② Switch the battery temperature unit

Long-press the  button under the battery temperature interface.

##### ③ Battery type

**Step1:** Press the  button to jump to the battery voltage interface.

**Step2:** Long-press the  button until the battery-type interface flashes.

**Step3:** Press the  button to change the battery type, shown below:

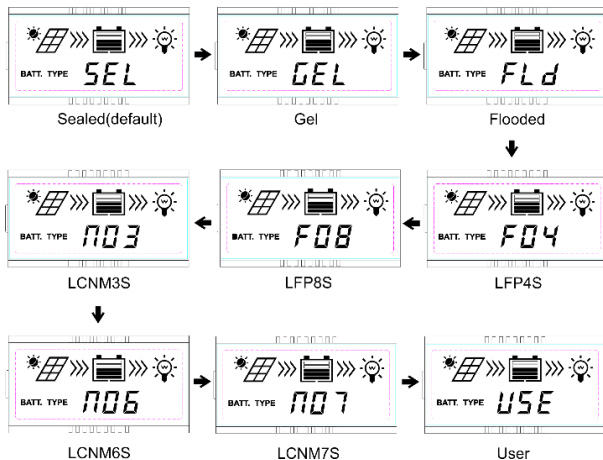



**Step4:** Press the  button to confirm.

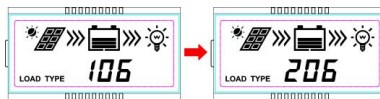

#### ④ Load type



#### Operating:

**Step1:** Press the  button to switch to the load type interface, and long-press the  button until the load type flashes.

**Step2:** Press the  button to select the load type.



**Step3:** Press the  button to confirm.

**NOTE:** Please refer to 5.2 for the load working modes.

#### 4.1.3 Display Standard 2 (DS2)



##### (1) Indicator





Indicator	Color	Status	Instruction
	Green	On Solid	PV charges the battery with a low current
	Green	OFF	1. No sunlight 2. Connection error 3. Low PV voltage
	Green	Slowly Flashing(1Hz)	Normal charging
	Green	Fast Flashing(4Hz)	PV Over voltage
	Green	On Solid	Normal
	Green	Slowly Flashing(1Hz)	Full
	Green	Fast Flashing(4Hz)	Over voltage
	Orange	On Solid	Under voltage
	Red	On Solid	Over discharged
	Red	Slowly Flashing(1Hz)	Battery Overheating Low temperature <sup>Ⓟ</sup>
	Yellow	On Solid	Load ON

	Yellow	OFF	Load OFF
PV&BATTLED fast flashing			Controller Overheating System voltage error <sup>②</sup>

① When a lead-acid battery is used, the controller doesn't have low-temperature protection.

② When a lithium-ion battery is used, the system voltage can't be identified automatically.





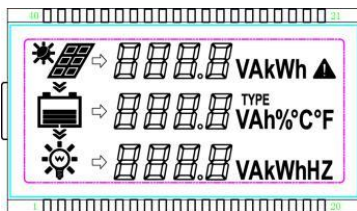

## (2) Button

	Press the button	PV browsing interface Setting data +
	Press the button and hold 5s	Setting the LCD cycle time
	Press the button	BATT browsing interface Cursor displacement during setting
	Press the button and hold 5s	Setting the battery type, battery capacity level, and temperature unit.
	Press the button	1. Inverter load browsing interface with RCM module 2. Controller load browsing interface with RCS module. Setting data -
	Press the button and hold 5s	Setting the load working mode with the RCS module.
	Press the button	Setting interface Setting interface switch to the browsing interface Setting the parameter to enter button
	Press the button	Turn on/off the inverter with the RCS module
		Exit the setting interface

## (3) Display

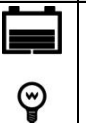

Note: The display screen can be viewed clearly when the angle between the end-users horizontal sight and the display screen is within 90°. If the angle exceeds 90°, the information on the display screen cannot be viewed clearly.

Icon	Information	Icon	Information	Icon	Information
	Day		Not charging		Not discharging
	Night		Charging		Discharging

### 1) PV parameters

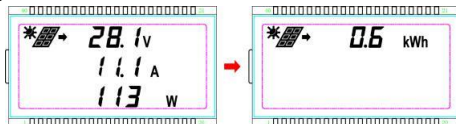

Display: Voltage/Current/Power/Generated Energy

### 2) Battery parameters

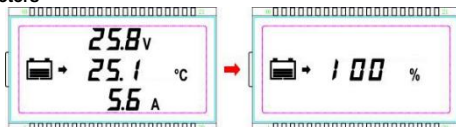

Display: Voltage/Current/Temperature/Battery capacity level

### 3) Load parameters

- Combination of the DS2 and RCM modules (To connect the system with the inverter, refer to 4.2.4)

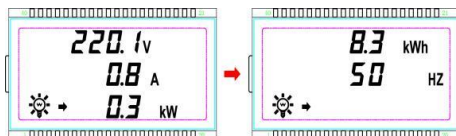

Display: Voltage/Current/Power/ Consumed energy/Frequency

- Combination of the DS2 and UCS modules with the LCD (connect a LED load: refer to 4.2.5)

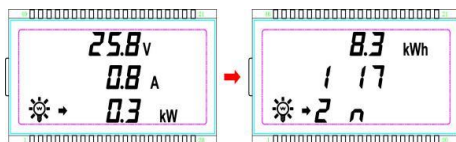



Display: Voltage/Current/Power/ Consumed energy/Load working mode-Timer1/ Load working mode-Timer2

#### (4) Setting parameters

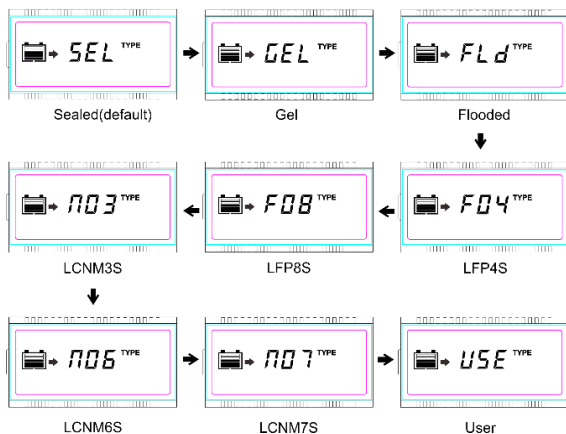

##### 1) Battery type



#### Operation:

**Step 1:** On the initial interface, press the  button to browse the battery parameters. Then, press the  button to enter the battery parameters setting interface.

**Step 2:** Long-press the  button to enter the battery-type interface.

**Step 3:** Press the  or  button to select the battery type.



**Step 4:** Press the  button to confirm the parameters.

**Step5:** Continue to press the  button twice or wait for 10S of no-operation to automatically go back to the battery parameters setting interface.

##### 2) Battery capacity





**Operation:**

**Step 1:** On the initial interface, press the  button to browse the battery parameters. Then, press the  button to enter the battery parameters setting interface.

**Step 2:** Long-press the  button to enter the battery-type interface.

**Step 3:** Press the  button for the battery capacity interface.

**Step 4:** Press the  or  button to set the battery capacity.

**Step 5:** Press the  button to confirm.

**3) Temperature unit**

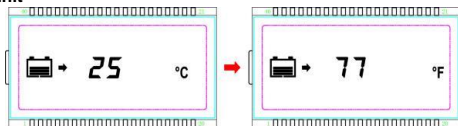

**Operation:**

**Step 1:** On the initial interface, press the  button to browse the battery parameters. Then, press the  button to enter the battery parameters setting interface.

**Step 2:** Long-press the  button to enter the battery-type interface.

**Step 3:** Press the  button twice for the temperature unit interface.

**Step 4:** Press the  or  button to set the temperature units.

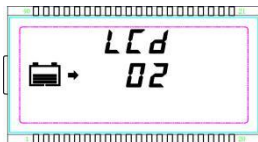

**Step 5:** Press the  button to confirm.

**4) LCD cycle time**





**NOTE:** The LCD cycle default time is 2s, and the setting time range is 0~20s.

### Operation:

**Step 1:** On the initial interface, press the  button to browse the PV parameters. Then, press the  button to enter the PV parameters setting interface.

**Step 2:** Long-press the  button to enter the LCD cycle time interface.



**Step 3:** Press the  or  button to set the LCD cycle time.

**Step 4:** Press the  button to confirm.

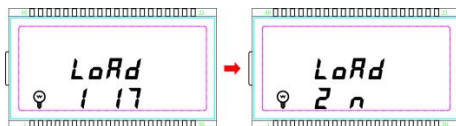
### 5) Local load type with the RCS module



### Operation:

**Step 1:** On the initial interface, press the  button to browse the load parameters. Then, press the  button to enter the load parameters setting interface.

**Step 2:** Long-press the  button to enter the load type interface.

**Step 3:** Press the  or  button to change the load type.

**Step 4:** Press the  button to confirm.

**NOTE:** Please refer to chapter 5.2 for the load working mode.

## 4.2 Interface Modules

### 4.2.1 Interface type

Interface	Interface type	Output voltage/current	Short circuit protection
USB output interface	Standard USB	5VDC/2.2A(Total)	Yes
RS485 com. interface	RJ45	5VDC/200mA	Yes
Relay interface	3.81-2P	30VDC/1A	NO

#### 4.2.2 Double USB (USB1)

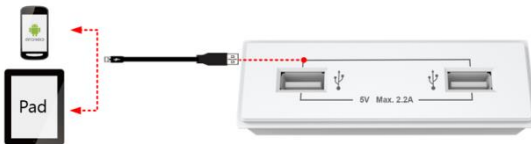

**USB output interface:**

Charging for phone, pad, etc. The Max. charging current is 2.2A(total).

**NOTE: USB interface output voltage/current is available when the load is ON.**

#### 4.2.3 USB COM Slave (UCS)



**USB output interface:** Charging for phone, pad, etc. The Max. charging current is 2.2A(total).

**NOTE: USB interface output voltage/current is available when the load is ON.**

**RS485 interface:** View working status and view/modify working parameters via the APP or PC software.

#### 4.2.4 Relay COM Master (RCM connects EPEVER inverter only)

**Note:** RCM can only be connected with the EPEVER inverters, not with optional accessories.

**RS485 interface:** When the master is set in RS485 communication mode, i.e., with a combination of the RCM and DS1/DS2 modules, the information of the inverter (to be supplied by our company) can be displayed by the DS1/DS2 module. See the following figure:

**Relay interface:** It shall connect the controller's relay in parallel with the inverter start switch, so it can turn ON/OFF the inverter by operating the button.

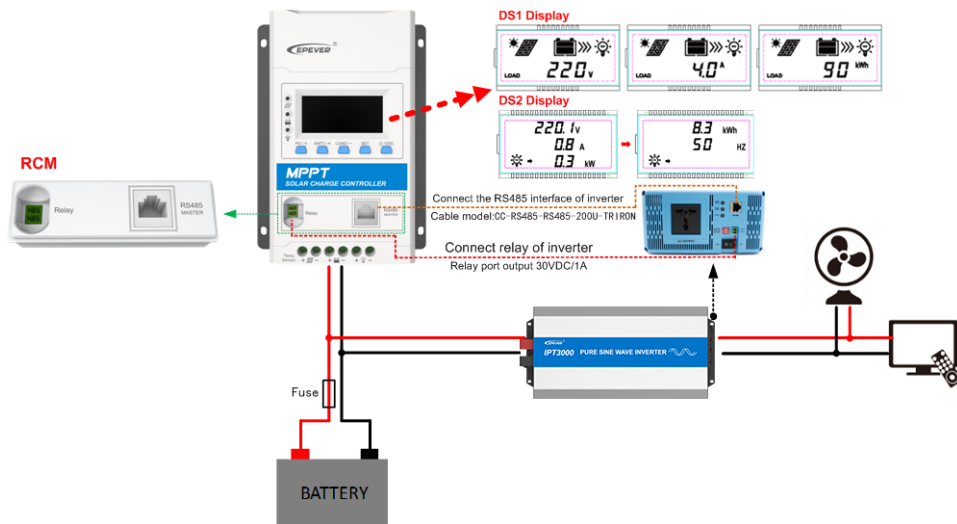



#### 4.2.5 Relay COM Slave (RCS connects the accessories)

**RS485 interface:** When the slave is set in RS485 communication mode, i.e., with a combination of the RCS and DS1/DS2 modules, the controller's information can be displayed by the DS1/DS2 module.

**Relay interface:** It shall connect the controller's relay in parallel with the inverter start switch, so it can turn ON/OFF the inverter by operating the button.

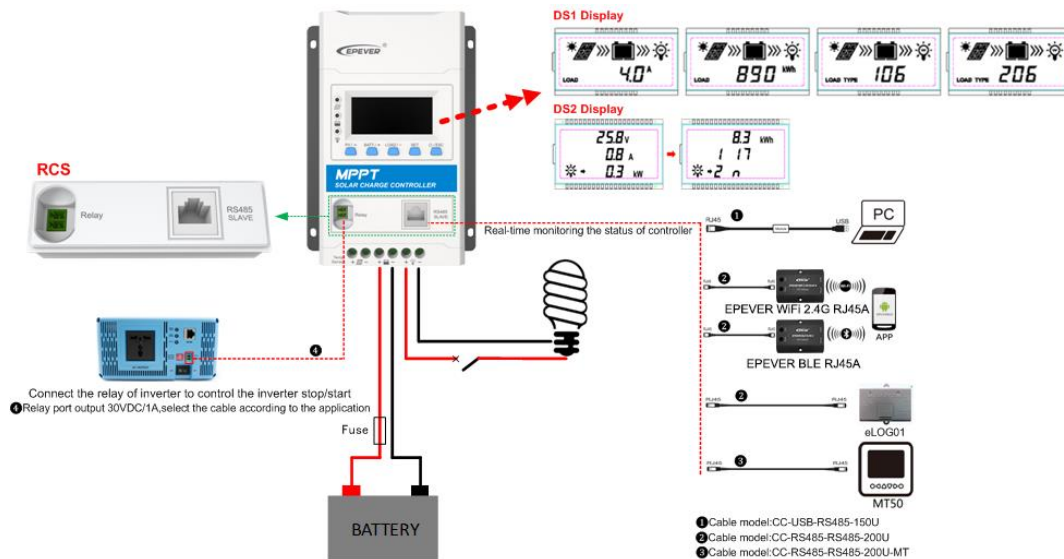

## 5 Parameters Setting

### 5.1 Battery parameters





#### 5.1.1 Supported battery types











1	Battery	Sealed(default)
		Gel
		Flooded
2	Lithium battery	LiFePO4(4S/ 8S)
		Li(NiCoMn)O2 (3S/6S/7S)
3	User	

#### 5.1.2 Local setting







 <b>WARNING</b>	When the default battery type is selected, the battery voltage parameters cannot be modified. To change these parameters, select the "USE" type.
---	--













**Step1:** Enter the "USE" battery type. Detailed operations of entering the "USE" battery type are shown in the following table.

Content	DS1 module operation steps	DS2 module operation steps
Enter the "USE" battery type	1) Press the  button to jump to the battery voltage interface, and long-press the  button to enter the battery-type interface. 2) Press the  button to select the battery type, such as	1) On the initial interface, press the  button to browse the battery parameters. Press the  button to enter the battery parameters setting interface, and long-press

	<p>select the battery type as F04. And then press the  button to confirm and back to the battery voltage interface automatically.</p> <p>3) Long-press the  button to enter the battery-type interface again on the battery voltage interface.</p> <p>4) Press the  button to select the battery type as "USE."</p>	<p>the  button to enter the battery-type interface.</p> <p>2) Press the  or  button to select the battery type, such as select the battery type as F04. And then press the  button to confirm. Continue to press the  button twice or wait for 10S of no-operation to automatically go back to the battery parameters setting interface.</p> <p>3) Long-press the  button to enter the battery-type interface again on the battery parameters setting interface.</p> <p>4) Press the  or  button to select the battery type "USE."</p>
--	--	---

**Step2: Set the battery parameters on the local device.** Under the "USE" interface, the battery parameters that can be local set are shown in the table below:

Parameters	Default	Range	DS1 module operation steps	DS2 module operation steps
System voltage level (SYS)★	12VDC	12/24VDC	<p>1) Under the "USE" battery type, press the  button to enter the "SYS" interface.</p> <p>2) Press the  button again to display the current "SYS" value.</p> <p>3) Press the  button to modify the parameter.</p>	<p>1) Under the "USE" battery type, press the  button to enter the "SYS" interface.</p> <p>2) Press the  button again to display the current "SYS" value.</p> <p>3) Press the  or  button to modify</p>

			4) Press the  button to confirm and enter the next parameter.	the parameter. 4) Press the  button to confirm and enter the next parameter.
Boost charging voltage (BCV)	14.4V	9—17	5) Press the  button again to display the current voltage value. 6) Press the  button to modify the parameter(short press to increase 0.1V, long press to decrease 0.1V). 7) Press the  button to confirm and enter the next parameter.	5) Press the  button again to display the current voltage value.
Float charging voltage (FCV)	13.8V	9—17		6) Press the  or  button to modify the parameter(press  button to increase 0.1V, press  button to decrease 0.1V).
Low voltage reconnect voltage (LVR)	12.6V	9—17		7) Press the  button to confirm and enter the next parameter.
Low voltage disconnect voltage (LVD)	11.1V	9—17		
Lithium battery protection enable (LEN)	NO	YES/NO		Press the  button to modify the switch status. <b>Note: It exists automatically from the current interface after no operation of more than 10S.</b>

★The SYS value can only be modified under the non-lithium "USE" type. The SYS value can be modified if the battery type is Sealed, Gel, or Flooded before entering the "USE" type. The SYS value cannot be modified if it is a lithium battery type before entering the "USE" type. Only the above battery parameters can be set on the local controller, and the remaining battery parameters follow the following logic. The voltage level of the 12V system is 1, and the voltage level of the 24V system is 2.

Battery type Battery parameters	Sealed/Gel/Flooded User	LiFePO4 User	Li(NiCoMn)O2 User
Over voltage disconnect voltage	BCV+1.4V*voltage level	BCV+0.3V*voltage level	BCV+0.3V*voltage level
Charging limit voltage	BCV+0.6V*voltage level	BCV+0.1V*voltage level	BCV+0.1V*voltage level
Over voltage reconnect voltage	BCV+0.6V*voltage level	BCV+0.1V*voltage level	Boost charging voltage
Equalize charging voltage	BCV+0.2V*voltage level	Boost charging voltage	Boost charging voltage
Boost reconnect charging voltage	FCV-0.6V*voltage level	FCV-0.6V*voltage level	FCV-0.1V*voltage level
Under voltage warning reconnect voltage(UVWR)	UVW+0.2V*voltage level	UVW+0.2V*voltage level	UVW+1.7V*voltage level
Under voltage warning voltage(UVW)	LVD+0.9V*voltage level	LVD+0.9V*voltage level	LVD+1.2V*voltage level
Discharging limit voltage	LVD-0.5V*voltage level	LVD-0.1V*voltage level	LVD-0.1V*voltage level

### 5.1.3 Remote Setting

#### 1) Setting the battery parameters by PC software

Connect the controller's RJ45 interface to the PC's USB interface via a USB to RS485 cable (model: CC-USB-RS485-150U). When selecting the battery type as "USE," set the voltage parameters by the PC software. Refer to the cloud platform manual for detail.

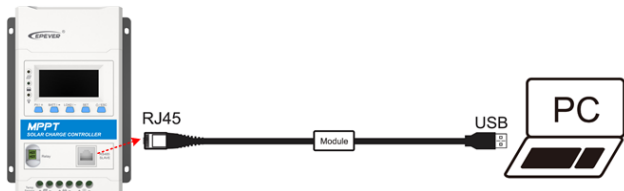

#### 2) Setting the battery parameters by APP

Connect the controller to the WIFI module through a standard network cable or connect to the Bluetooth module by Bluetooth signal. When selecting the battery type as "USE," set the voltage parameters by the APP. Refer to the cloud APP manual for details.

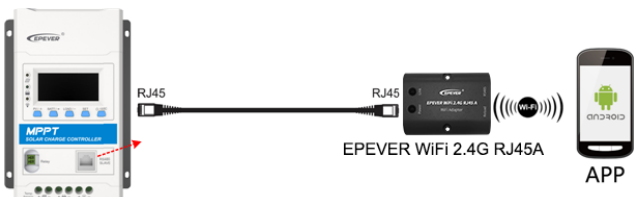

#### 3) Controller parameters

##### ◇ Battery voltage parameters

Measure the parameters in the condition of 12V/25°C. Please double the values in the 24V system.

Battery type Battery parameters	Sealed	GEL	FLD	User
Over voltage disconnect voltage	16.0V	16.0V	16.0V	9~17V
Charging limit voltage	15.0V	15.0V	15.0V	9~17V
Over voltage reconnect voltage	15.0V	15.0V	15.0V	9~17V
Equalize charging voltage	14.6V	—	14.8V	9~17V
Boost charging voltage	14.4V	14.2V	14.6V	9~17V
Float charging voltage	13.8V	13.8V	13.8V	9~17V

Boost reconnect charging voltage	13.2V	13.2V	13.2V	9~17V
Low voltage reconnect voltage	12.6V	12.6V	12.6V	9~17V
Under voltage warning reconnect voltage	12.2V	12.2V	12.2V	9~17V
Under voltage warning voltage	12.0V	12.0V	12.0V	9~17V
Low voltage disconnect voltage	11.1V	11.1V	11.1V	9~17V
Discharging limit voltage	10.6V	10.6V	10.6V	9~17V
Equalize Duration	120 minutes	--	120 minutes	0~180 minutes
Boost Duration	120 minutes	120 minutes	120 minutes	10~180 minutes

• **When the battery type is "USE," the battery voltage parameters follow the following logic:**

- A. Over Voltage Disconnect Voltage > Charging Limit Voltage ≥ Equalize Charging Voltage ≥ Boost Charging Voltage ≥ Float Charging Voltage > Boost Reconnect Charging Voltage.
- B. Over Voltage Disconnect Voltage > Over Voltage Reconnect Voltage
- C. Low Voltage Reconnect Voltage > Low Voltage Disconnect Voltage ≥ Discharging Limit Voltage.
- D. Under Voltage Warning Reconnect Voltage > Under Voltage Warning Voltage ≥ Discharging Limit Voltage;
- E. Boost Reconnect Charging voltage > Low Voltage Reconnect Voltage.

◇ **Lithium Battery voltage parameters**

Battery type Battery parameters	LFP		LNCM			User <sup>®</sup>
	LFP4S	LFP8S	LNCM3S	LNCM6S	LNCM7S	
Over voltage disconnect voltage	14.8V	29.6 V	12.8 V	25.6 V	29.8 V	9~17 V
Charging limit voltage	14.6 V	29.2 V	12.6 V	25.2 V	29.4 V	9~17 V
Over voltage reconnect voltage	14.6 V	29.2 V	12.5 V	25.0 V	29.1 V	9~17 V
Equalize charging voltage	14.5 V	29.0 V	12.5 V	25.0 V	29.1 V	9~17 V
Boost charging voltage	14.5 V	29.0 V	12.5 V	25.0 V	29.1 V	9~17 V

Float charging voltage	13.8 V	27.6 V	12.2 V	24.4 V	28.4 V	9~17 V
Boost reconnect charging voltage	13.2 V	26.4 V	12.1 V	24.2 V	28.2 V	9~17 V
Low voltage reconnect voltage	12.8 V	25.6 V	10.5 V	21.0 V	24.5 V	9~17 V
Under voltage warning reconnect voltage	12.2 V	24.4 V	12.2 V	24.4 V	28.4 V	9~17 V
Under voltage warning voltage	12.0 V	24.0 V	10.5 V	21.0 V	24.5 V	9~17 V
Low voltage disconnect voltage	11.1 V	22.2 V	9.3 V	18.6 V	21.7 V	9~17 V
Discharging limit voltage	11.0 V	22.0 V	9.3 V	18.6 V	21.7 V	9~17 V

① For LFP4S, the battery parameters under the “User” battery type are 9-17V; these parameters should be x2 for LFP8S.

- When the battery type is "USE," the Lithium battery voltage parameters follow the following logic:
  - A. Over Voltage Disconnect Voltage > Over Charging Protection Voltage (Protection Circuit Modules (BMS)) + 0.2V;
  - B. Over Voltage Disconnect Voltage > Over Voltage Reconnect Voltage = Charging Limit Voltage ≥ Equalize Charging Voltage = Boost Charging Voltage ≥ Float Charging Voltage > Boost Reconnect Charging Voltage;
  - C. Low Voltage Reconnect Voltage > Low Voltage Disconnect Voltage ≥ Discharging Limit Voltage.
  - D. Under Voltage Warning Reconnect Voltage > Under Voltage Warning Voltage ≥ Discharging Limit Voltage;
  - E. Boost Reconnect Charging voltage > Low Voltage Reconnect Voltage;
  - F. Low Voltage Disconnect Voltage ≥ Over Discharging Protection Voltage (BMS) + 0.2V

 <b>WARNING</b>	<p>The required accuracy of BMS is no higher than 0.2V. We will not assume responsibility for the abnormal when the accuracy of BMS is higher than 0.2 v.</p>
---	---



## 5.2 Load working modes

### 5.2.1 LCD setting

#### 1) DS1 module display and operation

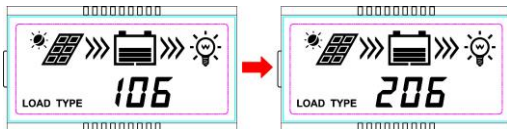

**Operation:**

**Step1:** Press the  button to switch to the load type interface.

**Step2:** Long-press the  button until the load type interface flashes.



**Step2:** Press the  button to select the load type.

**Step3:** Press the  button to confirm.

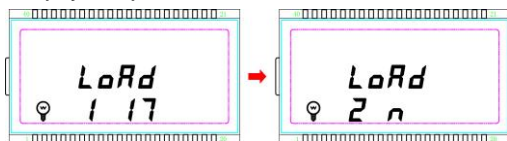

#### 2) DS2 module display and operation



**Operation:**

**Step1:** On the initial interface, press the  button to browse the load parameters. Then, press the  button to enter the load parameters setting interface.

**Step 2:** Long-press the  button to enter the load type interface.

**Step 3:** Press the  or  button to change the load type.

**Step 4:** Press the  button to confirm.

#### 3) Load mode

1**	Timer 1	2**	Timer 2
100	Light ON/OFF	2 n	Disabled
101	The load will be on for 1 hour since sunset	201	The load will be on for 1 hour before sunrise
102	The load will be on for 2 hours since sunset	202	The load will be on for 2 hours before sunrise

103 ~ 113	The load will be on for 3~13 hours since sunset	203 ~ 213	The load will be on for 3~13 hours before sunrise
114	The load will be on for 14 hours since sunset	214	The load will be on for 14 hours before sunrise
115	The load will be on for 15 hours since sunset	215	The load will be on for 15 hours before sunrise
116	Test mode	2 n	Disabled
117	Manual mode(Default load ON)	2 n	Disabled

 <b>WARNING</b>	When selecting the load mode as the Light ON/OFF mode, Test mode, and Manual mode, only the Timer 1 can be set, and the Timer 2 is disabled and display "2 n".
---	--

## 5.2.2 RS485 communication setting

### 1) Load working mode

- **Manual Control (default)**

Control ON/OFF of the load via the button or remote commands (e.g., APP or PC software).

- **Light ON/OFF**

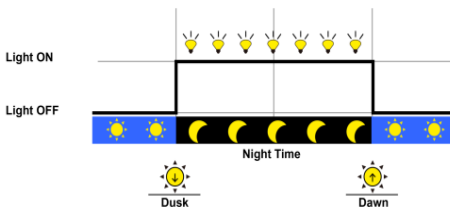

- **Light ON+ Timer**

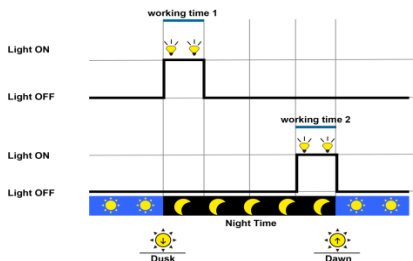

- **Time Control**

Control the load ON/OFF time by setting the real-time clock.

## 2) Load working mode settings

### (1) PC setting

Connect the controller's RJ45 interface to the PC's USB interface via a USB to RS485 cable (model: CC-USB-RS485-150U). Set the load mode by the PC software. Refer to the cloud platform manual for detail.

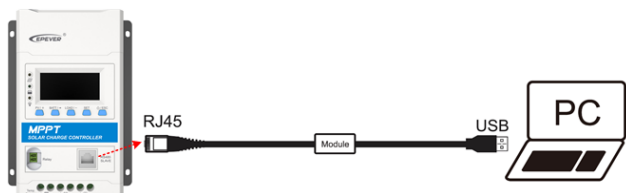

### (2) APP software setting

Connect the controller to the WIFI module through a standard network cable or connect to the Bluetooth module by Bluetooth signal. Set the load mode by the APP. Refer to the cloud APP manual for details.

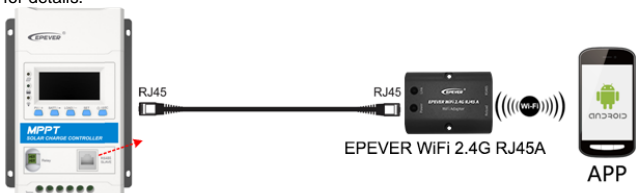





### (3) MT50 Setting



 <b>WARNING</b>	Please refer to the instructions for detailed setting methods or contact after-sales support.
---	---

## 6 Others

### 6.1 Protection

PV Over Current	<p>When the charging current or power of the PV array exceeds its rated current or power, it will be charged at the rated current or power.</p> <p> <b>WARNING: When the PV's charging current exceeds the rated current, the PV's open-circuit voltage cannot exceed the "maximum PV open-circuit voltage." Otherwise, the controller may be damaged.</b></p>
PV Short Circuit	<p>When not in a PV charging state, the controller will not be damaged in case of a short-circuiting in the PV array.</p> <p> <b>WARNING: It is forbidden to short-circuit the PV array during charging. Otherwise, the controller may be damaged.</b></p>
PV Reverse Polarity	<p>When the polarity of the PV array is reversed, the controller may not be damaged and can continue to operate normally after the polarity is corrected.</p> <p> <b>WARNING: The controller will be damaged when the PV array is connected reversely to the controller and the PV array's actual power exceeds 1.5 times the rated charging power.</b></p>
Night Reverse Charging	<p>Prevents the battery from discharging through the PV module at night.</p>
Battery Reverse Polarity	<p>Fully protected against reverse battery polarity; no damage to the controller will result. Correct the miswire to resume normal operation.</p> <p> <b>WARNING: The controller will be damaged when the PV connection is correct and the battery connection is reversed.</b></p>
Battery Over Voltage	<p>When the battery voltage reaches the over voltage disconnect voltage, it will automatically stop battery charging to prevent battery damage caused by over-charging.</p>
Battery Over Discharge	<p>When the battery voltage reaches the low voltage disconnect voltage, it will automatically stop battery discharging to prevent battery damage caused by over-discharging. (Any connected loads will be disconnected. Loads directly connected to the battery will not be affected and may continue to discharge the battery.)</p>
Battery Overheating	<p>The controller can detect the battery temperature through an external temperature sensor. The controller stops working when its</p>













	temperature exceeds 65 °C and begins working when its temperature is below 55 °C.
Lithium Battery Low Temperature	When the temperature detected by the optional temperature sensor is lower than the Low Temperature Protection Threshold(LTPT), the controller will stop charging and discharging automatically. When the detected temperature is higher than the LTPT, the controller will work automatically (The LTPT is 0 °C by default and can be set within 10 ~ -40 °C).
Load Short Circuit	When the load is short-circuited (The short circuit current is $\geq 4$ times the rated controller load current), the controller will automatically cut off the output. Suppose the load reconnects the output five times (delay of 5s, 10s, 15s, 20s, 25s). In that case, it needs to be cleared by pressing the Load button, restarting the controller, or switching from Night to the Day (nighttime > 3 hours).
Load Overload	When the load is overloading (The overload current is $\geq 1.05$ times the rated load current), the controller will automatically cut off the output. Suppose the load reconnects five times (delay of 5s, 10s, 15s, 20s, 25s). In that case, it needs to be cleared by pressing the Load button restarting the controller, or switching from Night to Day (nighttime > 3 hours).
Controller Overheating*	The controller can detect the temperature inside the battery through an optional remote sensor. The controller stops working when its temperature exceeds 85 °C and begins working when it is below 75 °C.
TVS High Voltage Transients	The internal circuitry of the controller is designed with Transient Voltage Suppressors (TVS), which can only protect against high-voltage surge pulses with less energy. Suppose the controller is to be used in an area with frequent lightning strikes. In that case, it is recommended to install an external surge arrester.

★When the internal temperature is 81 °C, the reducing power charging mode is turned on. It reduces the charging power by 5%,10%,20%, and 40% with every increase of 1 °C. If the internal temperature exceeds 85 °C, the controller will stop charging. But while the temperature declines below 75 °C, the controller resumes.

## 6.2 Troubleshooting

### • Controller Faults

Faults	Possible reasons	Troubleshooting
Charging LED indicator off during daytime when sunshine falls on PV modules properly	PV array disconnection	Confirm that PV and battery wire connections are correct and tight
The wire connection is correct, and the controller is not working.	Battery voltage is lower than 9V	Please check the battery voltage. At least 9V to activate the controller.

<p><b>DB1:</b> Charging indicator Green fast flashing</p>	<p>Battery over voltage</p>	<p>Check if the battery voltage is higher than OVD (over voltage disconnect voltage), and disconnect the PV.</p>
<p><b>DS1:</b>   Battery level shows full, battery frame and fault icon blink.</p>		
<p><b>DS2:</b> Charging indicator Green fast flashing   Battery level shows full, battery frame and fault icon blink.</p>		
<p><b>DB1:</b> Battery indicator Red on solid</p>	<p>Battery over-discharged</p>	<p>When the battery voltage is restored to or above LVR (low voltage reconnect voltage), the load will recover</p>
<p><b>DS1:</b>   Battery level shows empty, battery frame and fault icon blink.</p>		
<p><b>DS2:</b> Battery indicator Red on solid   Battery level shows empty, battery frame and fault icon blink.</p>		
<p><b>DB1:</b> Battery indicator Red slowly flashing</p>	<p>Battery Overheating</p>	<p>The controller will automatically turn the system off. But while the temperature declines below 55 °C, the controller will resume.</p>
<p><b>DS1:</b>   battery frame and fault icon blink.</p>		
<p><b>DS2:</b> Battery indicator Red slowly flashing   battery frame and fault icon blink.</p>		

<b>DB1</b> PV/BATT(orange)/Battery capacity lever(four) indicator fast flashing <b>DS2:</b> PV/BATT(orange)indicator fast flashing	Controller Overheating	When the controller heat sink exceeds 85℃, the controller will automatically cut the input and output circuit. When the temperature is below 75℃, the controller will resume work.
	System voltage error	① Check whether the battery voltage matches the controller's working voltage. ② Please change to a suitable battery or reset the working voltage.
The load is no output DS1/DS2:  Load and fault icon blink	Load Overload <b>Fault code E002(only DS2)</b>	① Please reduce the number of electric equipment. ② Restart the controller. ③ Wait for one night-day cycle (night time>3 hours).
	Load Short Circuit <b>Fault code E001(only DS2)</b>	① Check carefully load connection, and clear the fault. ② Restart the controller. ③ Wait for one night-day cycle (night time>3 hours).

• **Inverter fault**

Inverter fault	Fault code	LCD	Indicator
Output short circuit	E001	Fault icon blink (1S)	Load indicator blink
Output overload	E002		
Output voltage abnormal	E003		
Input over voltage	E005		
Input low voltage	E006		
Input over current	E007		
Overheating	E008		
Communication timeout	E099★		

 <b>WARNING</b>	<ul style="list-style-type: none"> <li>The controller connects our company's inverter only, when it connects the purchased inverter, the LCD shows E099.</li> <li>With combination of the RCM and DS1/DS2 modules, the information of the inverter (to be supplied by our company) can be displayed by the DS1/DS2 module.</li> </ul>
---	---

## 6.3 Maintenance

The following inspections and maintenance tasks are recommended at least twice yearly for best performance.

- Make sure the controller is firmly installed in a clean and dry ambient.
- Make sure no block on airflow around the controller. Clear up any dirt and fragments on the radiator.
- Check all the naked wires to ensure insulation is not damaged by serious solarization, frictional wear, dryness, insects or rats, etc. Repair or replace some wires if necessary.
- Tighten all the terminals. Inspect for loose, broken, or burnt wire connections.
- Check and confirm that LED is consistent with required. Pay attention to any troubleshooting or error indication. Take corrective action if necessary.
- Confirm that all the system components are ground connected tightly and correctly.
- Confirm that all the terminals have no corrosion, insulation damage, high temperature, or burnt/discolored sign. Tighten terminal screws to the suggested torque.
- Check for dirt, nesting insects, and corrosion. If so, clear up in time.
- Check and confirm that the lightning arrester is in good condition. Replace a new one in time to avoid damaging the controller and other equipment.



**WARNING**

Risk of electric shock!

Ensure all the power is turned off before the above operations, and then follow the corresponding inspections and operations.



## 7 Technical Specifications

### Electrical Parameters

Item	TRIRON 1206N	TRIRON 2206N	TRIRON 1210N	TRIRON 2210N	TRIRON 3210N	TRIRON 4210N	TRIRON 3215N	TRIRON 4215N
System nominal voltage	12/24VDC Auto <sup>①</sup>							
Rated charge current	10A	20A	10A	20A	30A	40A	30A	40A
Rated discharge current	10A	20A	10A	20A	30A	40A	30A	40A
Battery voltage range	8~32V							
Max. PV open circuit voltage	60V <sup>②</sup> / 46V <sup>③</sup>		100V <sup>②</sup> / 92V <sup>③</sup>				150V <sup>②</sup> / 138V <sup>③</sup>	
MPP voltage range	(Battery voltage +2V)~36V		(Battery voltage +2V)~72V				(Battery voltage +2V)~108V	
Rated charge power	130W/12V 260W/24V	260W/12V 520W/24V	130W/12V 260W/24V	260W/12V 520W/24V	390W/12V 780W/24V	520W/12V 1040W/24V	390W/12V 780W/24V	520W/12V 1040W/24V
Self-consumption	≤14mA(12V), ≤15mA(24V)						≤15mA(12V), ≤10mA(24V)	
Discharge circuit voltage drop	≤0.18V							
Temp. compensate coefficient <sup>④</sup>	-3mV/°C/2V (Default)							
Grounding	Common negative							
RS485 interface	5VDC/200mA							
USB interface	5VDC/2.2A(Total)							
Relay interface	30VDC/1A							
Backlight time	Default:60S, Range:0~999S(0S: the backlight is ON all the time)							

①When a lithium battery is used, the system voltage can't be identified automatically.

②At minimum operating environment temperature    ③At 25°C environment temperature

④When a lithium battery is used, the temperature compensation coefficient will be 0 and can't be changed.

#### Environmental Parameters

Environment temperature*	-25°C~+55°C(LCD), -30°C~+55°C(No LCD)	-25°C~+50°C(LCD), -30°C~+50°C(No LCD)
Storage temperature range	-20°C~+70°C	
Relative humidity	≤95%, N.C	
Enclosure	IP30	

※The controller can full load working in the working environment temperature. When the internal temperature is 81°C, the reducing power charging mode is turned on. Refer to chapter 6.1 Protection.

#### Mechanical Parameters

Item	TRIRON1206N TRIRON1210N	TRIRON2206N TRIRON2210N	TRIRON3210N	TRIRON3215N TRIRON4210N/TRIRON4215N
Dimension (LxWxH)	135x180.8x47.3mm	150x216x56.7mm	158x238.3x62.7mm	183x256.8x66.7mm
Mounting size (LxW)	126x150mm	141x170mm	158x200mm	174x220mm
Mounting hole size	Φ5mm			
Terminal	12AWG(4mm <sup>2</sup> )	6AWG(16mm <sup>2</sup> )	6AWG(16mm <sup>2</sup> )	6AWG(16mm <sup>2</sup> )
Recommended cable	12AWG(4mm <sup>2</sup> )	10AWG(6mm <sup>2</sup> )	8AWG(10mm <sup>2</sup> )	8AWG(10mm <sup>2</sup> )(TRIRON3215N) 6AWG(16mm <sup>2</sup> )
Weight	0.56kg	0.92kg	1.35kg	1.85kg

#### Module Parameters

Item	DB1	DS1	DS2	UCS	RCM	RCS	USB1
Self-consumption	2mA	3mA	4mA	6.5mA	3.5mA	4mA	6.5mA
Dimension	88.5x56x23.1mm			88.5x28x19.2mm			
Weight	25g	55g	55g	30g	20g	20g	26g

# Annex I Conversion Efficiency Curves

Illumination Intensity: 1000W/m<sup>2</sup> Temperature: 25°C

Model: TRIRON1206N

## 1. Solar Module MPP Voltage(17V, 34V) / Nominal System Voltage(12V)

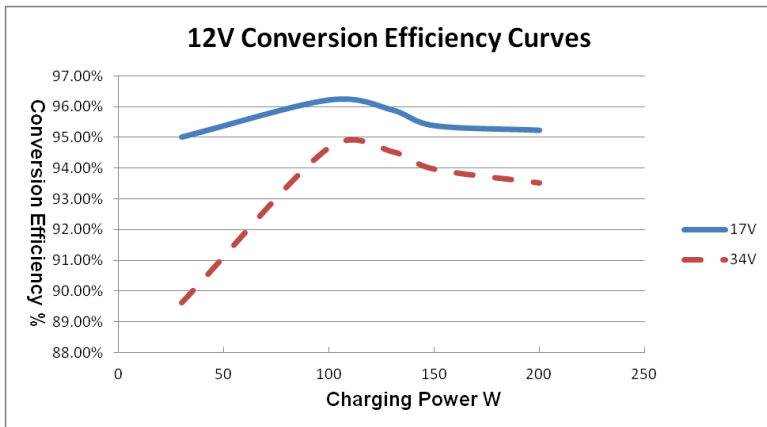

## 2. Solar Module MPP Voltage(34V) / Nominal System Voltage(24V)

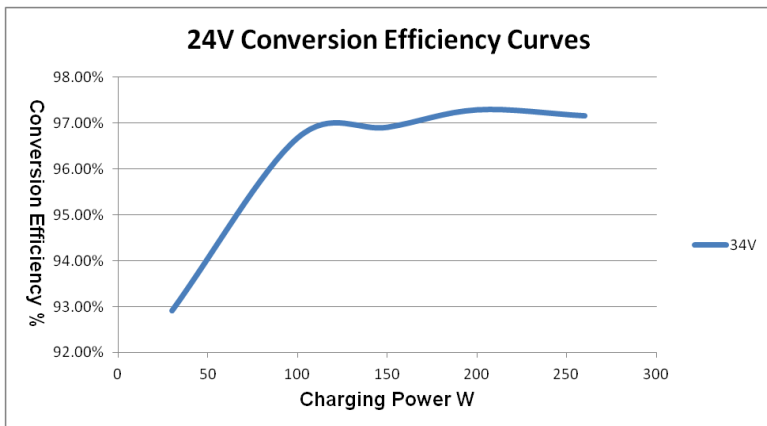

Model: TRIRON1210N

1. Solar Module MPP Voltage(17V, 34V) / Nominal System Voltage(12V)

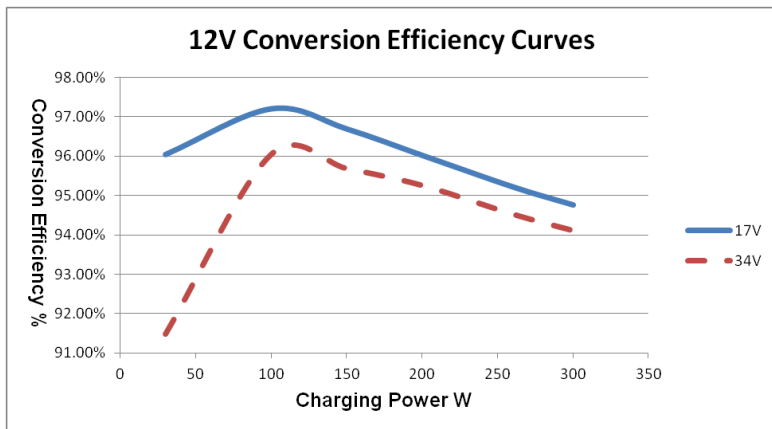

2. Solar Module MPP Voltage(34V) / Nominal System Voltage(24V)

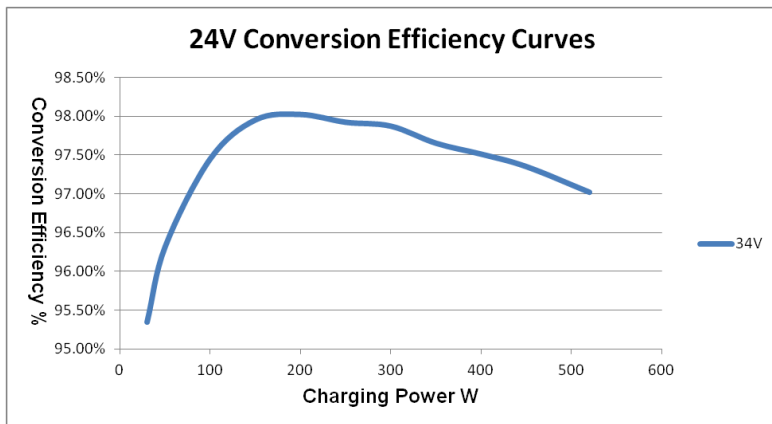

Model: TRIRON2206N

1. Solar Module MPP Voltage (17V, 34V) / Nominal System Voltage(12V)

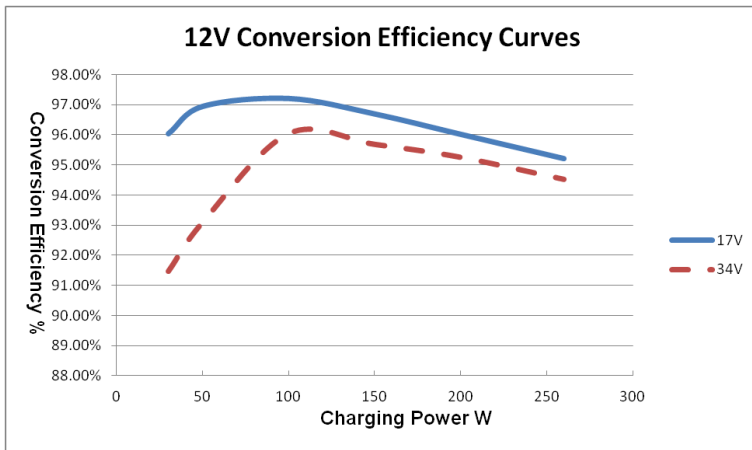

2. Solar Module MPP Voltage (34V) / Nominal System Voltage(24V)

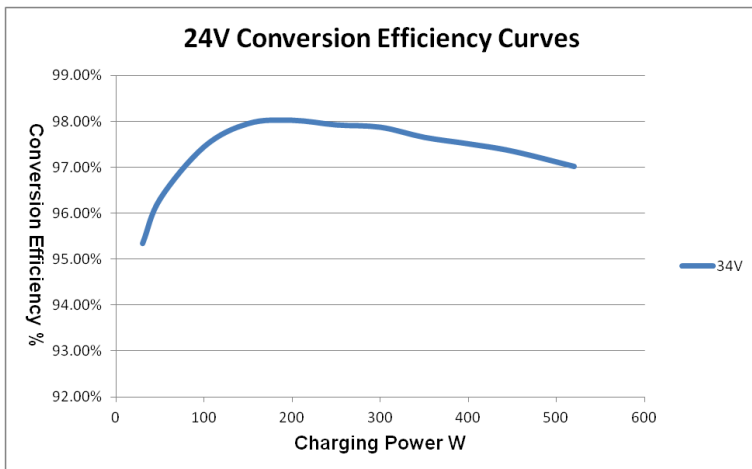

Model: TRIRON2210N

1. Solar Module MPP Voltage (17V, 34V,51V) / Nominal System Voltage(12V)

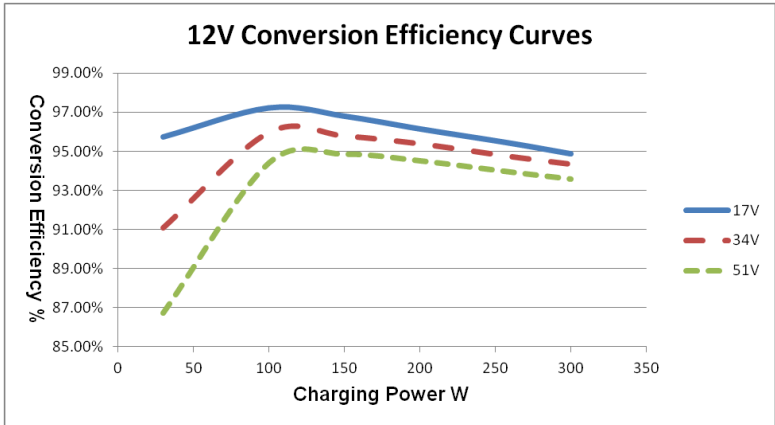

2. Solar Module MPP Voltage (34V,51V,68V) / Nominal System Voltage(24V)

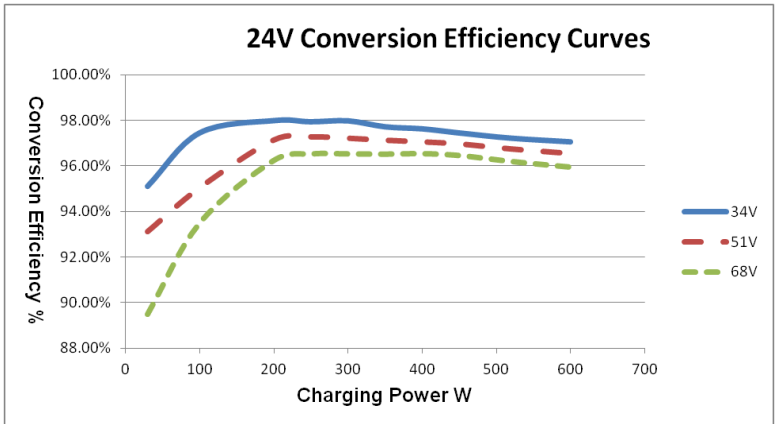

Model: TRIRON3210N

1. Solar Module MPP Voltage (17V, 34V,51V) / Nominal System Voltage(12V)

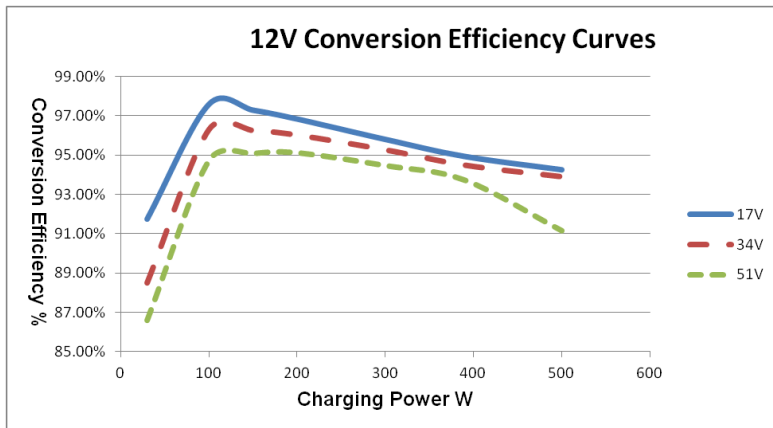

2. Solar Module MPP Voltage (34V,51V,68V) / Nominal System Voltage(24V)

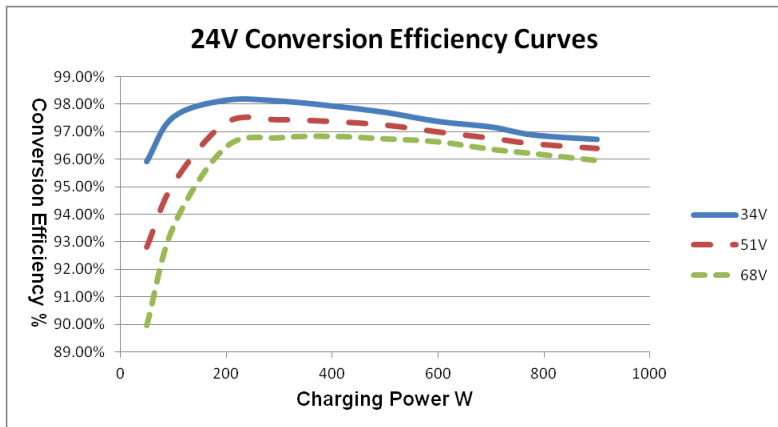

Model: TRIRON3215N

1. Solar Module MPP Voltage (17V, 34V,68V) / Nominal System Voltage(12V)

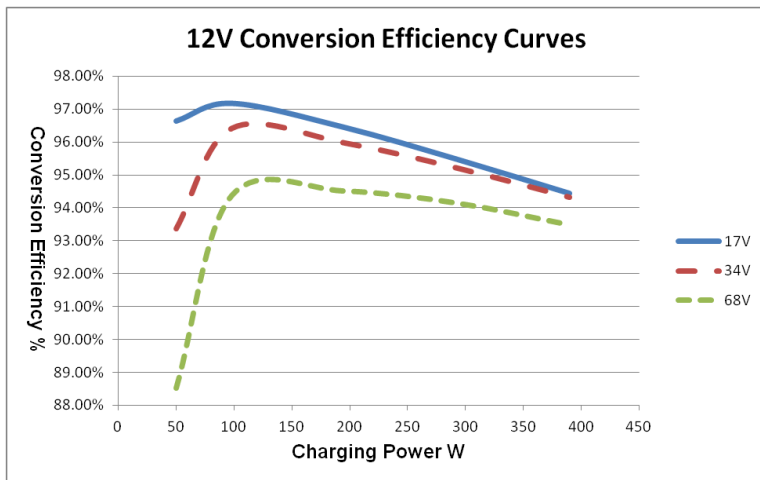

2. Solar Module MPP Voltage (34V,68V,102V) / Nominal System Voltage(24V)

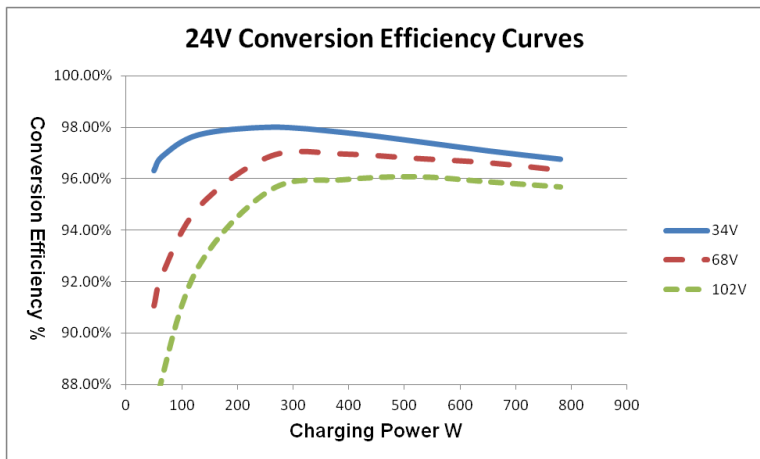



Model: TRIRON4210N

1. Solar Module MPP Voltage (17V, 34V,51V) / Nominal System Voltage(12V)

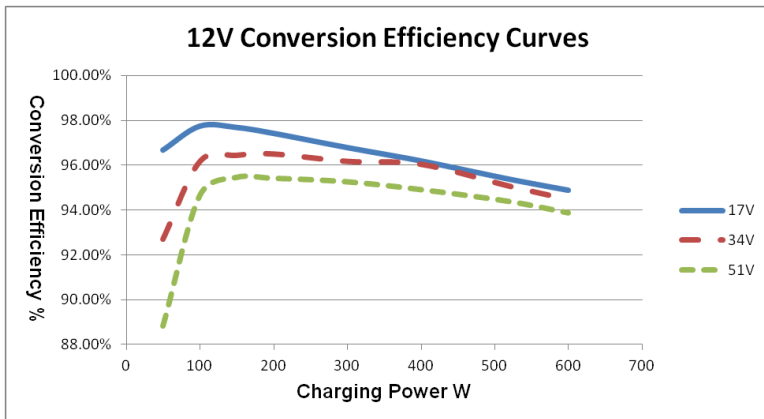

2. Solar Module MPP Voltage (34V,51V,68V) / Nominal System Voltage(24V)

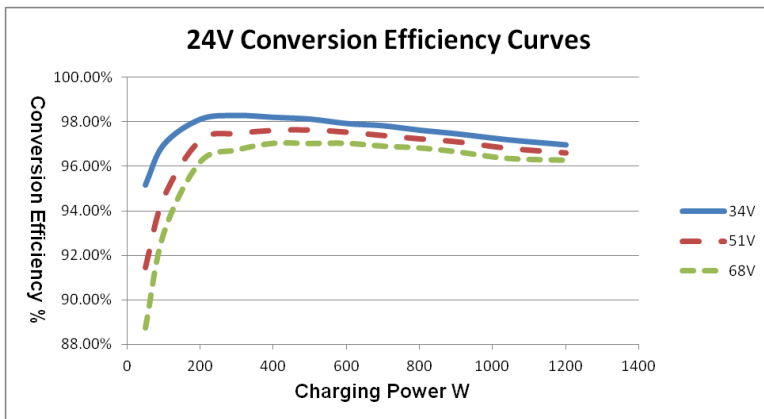

Model: TRIRON4215N

1. Solar Module MPP Voltage (17V, 34V,68V) / Nominal System Voltage(12V)

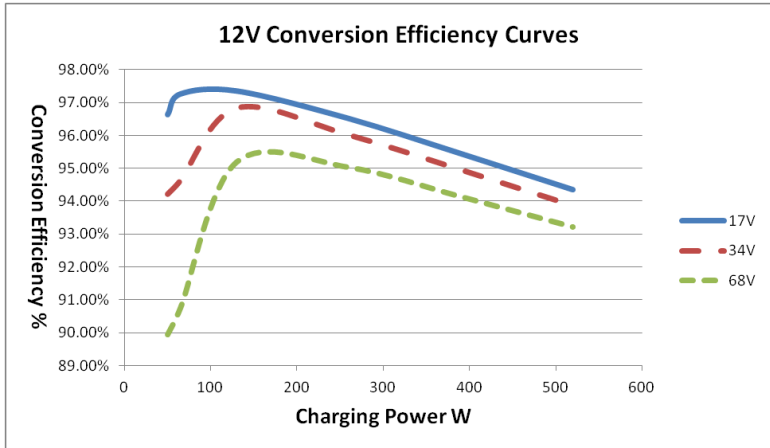

2. Solar Module MPP Voltage (34V,68V,102V) / Nominal System Voltage(24V)

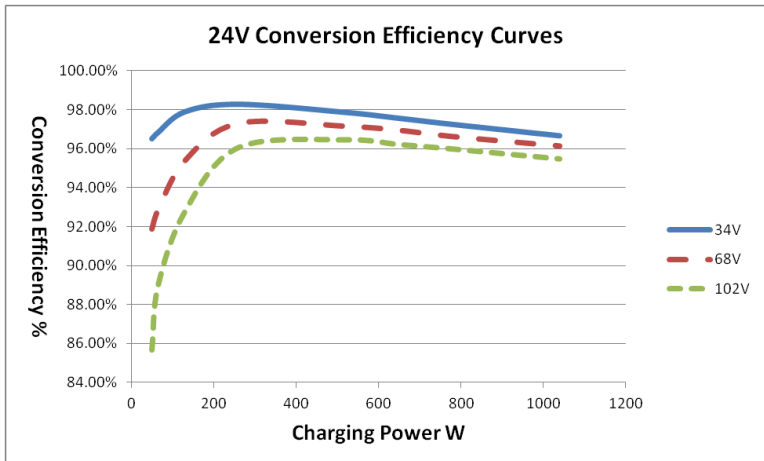

Any changes without prior notice!

Version number: 2.4



**HUIZHOU EPEVER TECHNOLOGY CO., LTD.**

**Tel: +86-752-3889706**

**E-mail: [info@epever.com](mailto:info@epever.com)**

**Website: [www.epever.com](http://www.epever.com)**