



User Manual

PV Grid-Connected Inverter
SPI-B2 Series (1500-6000)

Copyright © Xiamen KehuaHengshengCo.,Ltd.2018.All rights reserved.

No part of this document may be reproduced or transmitted in any form or by any means without prior written consent of Xiamen Kehua Hengsheng Co., Ltd.

Trademarks and Permissions



and other Kehua trademarks are trademarks of Xiamen Kehua Hengsheng Co., Ltd.

All other trademarks and trade names mentioned in this document are the property of their respective holders.

Notice

The purchased products, services and features are stipulated by the contract made between Kehua and the customer. All or part of the products, services and features described in this document may not be within the purchase scope or the usage scope. Unless otherwise specification in the contract, all statements, information, and recommendations in this document are provided "AS IS" without warranties, guarantees or representations of any kind, either express or implied.

The information in this document is subject to change without notice. Every effort has been made in the preparation of this document to ensure accuracy of the contents, but all statements, information, and recommendations in this document do not constitute a warranty of any kind, express or implied.

XIAMENKEHUA HENGSHENG CO.,LTD.

Address:	No.457,MalongRoad,TorchHigh-TechIndustrialZone,Xiamen,Fujian,China
Manufacturer:	ZHANGZHOU KEHUA TECHNOLOGYCO.,LTD.
Postal Code:	361000(XIAMEN), 363000(ZHANGZHOU)
Website:	www.kehua.com
E-mail:	service@kehua.com
Customer Service Telephone:	400-808-9986
Tel:	0592-5160516
Fax:	0592-5162166

Foreword

Summaries

Thank you for choosing Kehua's string PV Grid-Connected Inverter (hereinafter referred to as the "inverter").

This document gives a description of SPI-B2 series inverter, including the features, performance, appearance, structure, working principles, installation, operation and maintenance.etc.

Please save the manual after reading, in order to consult in the future.



NOTE

The figures in this manual are just for reference, for details please see the actual product.



Suitable Model





The manual is suitable for following models:

- SPI1500-B2, SPI2000-B2, SPI3000-B2
- SPI3600-B2, SPI4000-B2, SPI4600-B2, SPI5000-B2, SPI6000-B2

Symbol Conventions

The manual quotes the safety symbols, these symbols used to prompt users to comply with safety matters during installation, operation and maintenance. Safety symbol meanings follows.

Symbol	Description
 DANGER	Alerts you to a high risk hazard that could, if not avoided, result in serious injury or death.
 WARNING	Alerts you to a medium or low risk hazard that could, if not avoided, result in moderate or minor injury.
 CAUTION	Alerts you to a potentially hazardous situation that could, if not avoided, result in equipment damage, data loss, performance deterioration, or unanticipated results.

Symbol	Description
	Anti-static prompting.
	Be care electric shock prompting.
 TIP	Provides a tip that may help you solve a problem or save time.
 NOTE	Provides additional information to emphasize or supplement important points in the main text.

Product standard: NB/T 32004-2013

Revision History

Changes between document versions are cumulative. The latest document version contains all the changes made in earlier version.

Version 005 (2018-07-24)

- 1、Delete DRM Figure.

Version 004 (2018-07-12)

1. Add 错误!未找到引用源。 错误!未找到引用源。 .
2. Renew 4 LCD Operation.
3. Renew 3.5.6 Communication Port Connection (Optional)

Version 003 (2018-06-08)

Renew Figure3-25, Figure3-26.

Version 002 (2018-05-30)

Renew the CATION illustration in section 3.5.1.

Version 001 (2018-04-13)

First release.

Contents

1 Safety Description.....	1
1.1 Safety Announcements	1
1.1.1 Safety Instructions	1
1.1.2 Protection for PV Array	3
1.1.3 Anti-Static Protection	3
1.1.4 Grounding Requirements	3
1.1.5 Moisture-proof Protection	4
1.1.6 Safety Warning Label Setting	4
1.1.7 Electrical Connection	4
1.1.8 Measure with Electricity	5
1.2 Requirements for Operator	5
1.3 Environment Requirements	6
2 Overview.....	7
2.1 Product Intro.....	7
2.1.1 Model Meaning	7
2.1.2 Product Features.....	7
2.2 Appearance and Structure.....	8
2.2.1 Operation Panel.....	8
2.2.2 External Terminal Illustration	9
2.3 Work Principle.....	11
3 Installation Guide	12
3.1 Installation Process.....	12
3.2 Installation Preparation	12
3.2.1 Tools.....	12

3.2.2 Installation Environment.....	13
3.2.3 Installation Space.....	14
3.2.4 Installation Way.....	15
3.3 Transportation and unpacking.....	15
3.3.1 Transportation.....	15
3.3.2 Unpacking and Checking.....	16
3.4 Installation.....	16
3.5 Electrical Connection.....	20
3.5.1 Wire Requirement.....	20
3.5.2 External Grounding Connection.....	21
3.5.3 DC Input (PV) Connection.....	22
3.5.4 AC Output (GRID) Connection.....	24
3.5.5 WIFI/GPRS Connection.....	27
3.5.6 Communication Port Connection (Optional).....	27
3.6 Check the Installation.....	30
4 LCD Operation.....	31
4.1 First Startup.....	31
4.2 Main Page.....	31
4.3 Main Menu Page.....	32
4.3.1 Running Information.....	33
4.3.2 Power Query.....	34
4.3.3 Record Query.....	34
4.3.4 System Setting.....	36
4.3.5 System Information.....	39
5 Startup and shutdown.....	41
5.1 Startup.....	41
5.2 Shutdown.....	41
6 Maintenance and Troubleshooting.....	42
6.1 Maintenance.....	42

6.2 Troubleshooting.....	42
7 Package, Transportation and Storage.....	45
7.1 Package	45
7.2 Transportation	45
7.3 Storage	45
A Technical Specifications	46
B Acronyms and Abbreviations	50

1 Safety Description

This chapter introduces the safety announcements. Please read this user manual carefully prior to installing the inverter. It provides important information on safe and efficient installation.

1.1 Safety Announcements



CAUTION

Before operation, please read the announcements and operation instructions in this part, which is to avoid accident.

The DANGER, WARNING, CAUTION in the manual, are not all the safety announcements that must be abided by, they are just the supplement of the safety announcements during operating.



NOTE

Kehua Company does not undertake the responsibility caused by violating common safety operation requirements or the safety standard of design, manufacture and use.

1.1.1 Safety Instructions



DANGER

It is prohibited touching any terminal or conductor that connected with grid circuit, or, it may cause deadly danger.

**DANGER**

There is no operational part inside the inverter. Please do not open the crust of the inverter by yourself, or it may cause electric shock. The inverter damage caused by illegal operation is out of the guarantee range.

**DANGER**

The damaged device or device fault may cause electric shock or firing!

- Before operating, please inspect the device and see if there is any damage or exist other danger.
 - Check if the external devices or circuit connection is safe.
-

**DANGER**

Before checking or maintenance, if the DC side and AC side is power down just now, it is necessary to wait for 5 minutes to ensure the inner device is completely discharged, and then the operation can be performed.

**HIGH TEMPERATURE**

The surface temperature of the inverter may reach to 75°C. During running, please don't touch the surface to avoid scald.

**CAUTION**

No liquid or other objects are allowed to enter the inverter.

**CAUTION**

In case fire, please use dry power fire extinguisher. If using liquid fire extinguisher, it may cause electric shock.

1.1.2 Protection for PV Array

When install the PV array in the daytime, use light-proof material to cover the PV array, or, under the sunshine, the PV array will generate high voltage. Once touch the PV array by accident, it may cause electric shock or endanger human life.

**DANGER**

There is deadly high voltage between the positive and negative of the PV array.

During installing, ensure that the connection between inverter and PV array is completely disconnected and set warning marks at the disconnection to avoid reconnecting by accident.

1.1.3 Anti-Static Protection

**CAUTION**

The static electricity generated by human bodies may damage the electrostatic-sensitive components on boards. Before touching the sensitive component, please wear anti-static rings and well connect the other end of the anti-static rings to ground.

1.1.4 Grounding Requirements

**WARNING**

High leakage risk! The inverter must be grounded before electrical connection. The ground terminal must be connected to earth.

- When installing, connect the grounding wire first; when dismantling, the grounding wire must be removed at last.

- It is prohibited to damage the grounding conductor.
- The device must be connected with protection earthing permanently. Before operating, please check the electric connection and ensure the device has been connected to earth reliably.

1.1.5 Moisture-proof Protection



CAUTION

Moisture incursion may cause the inverter damage!

For normal use of the energy-storage converter, please comply with the following items.

- If the atmosphere humidity larger than 95%, please do not open the inverter.
- On overcast or rainy or moist condition, avoid opening the panel to maintain or do other operation.

1.1.6 Safety Warning Label Setting

To avoid irrelevant person close to or misoperate the inverter, during installation or daily maintenance, please abide by the related standards.

- Set warning labels at the front end and back end of the inverter to avoid wrongly close and even cause accident.
- Set warning label board or safety warning area to avoid irrelevant person entering and cause human injury or device damage.

1.1.7 Electrical Connection

The electrical connection must be done on the basis of the illustration and electrical wiring principle mentioned in this manual.



WARNING

The PV array and grid level, frequency, etc. must accord with the inverter's specification.

The grid-connected generation must be allowed by local power supply department and operate by professionals.

All the electrical connection must accord with the electrical installation standard of local nation and district.

1.1.8 Measure with Electricity



CAUTION

There is dangerous high voltage, contacting by accident may lead to deadly danger. So, when measure with electricity, it is necessary to do the protection (such as wear insulated gloves, etc.)

The measure meter must accord with the following requirements.

- The range and sue condition of the measure meter should conform to the site requirements.
- Ensure that connection of the measure meter is proper and normative, which is to avoid the danger of electric arc, etc.

1.2 Requirements for Operator



CAUTION

The related operation and wiring for the inverter should be performed by qualified professionals, and ensure the electric installation accord with the electricity installation standards.

The installation and maintenance man should be trained and know each safety announcements and get the right operation method, and then, the installation, operation and maintenance can be done.

- The operator should be familiar with the constitution and work principle of the whole PV grid-connected generation system.
- The operator must be acquainted with the related standards of local nation and region.

1.3 Environment Requirements



CAUTION

Avoid the inverter suffering directly sunshine, rain or snow to prolong the service life (detail please see 3.2.2). If the installation environment does not meet the requirement, the guarantee time may be influenced.

The used environment may influence the service life and reliability of the inverter. So, please avoid using the inverter in the following environment for long time.

- The place where beyond the specification (normal work temperature: $-30^{\circ}\text{C} \sim 60^{\circ}\text{C}$, relative humidity: 0%-95%).
- The place where has vibration or easy impacted.
- The place where has dust, corrosive material, salty or flammable gas.
- The place where without good ventilation or closed.

2 Overview

This chapter mainly introduces the inverter features, appearance, operation panel, work principle, etc.

2.1 Product Intro

The inverter is the device that converts DC energy from solar array into AC energy and then feedbacks to power grid. It is suitable for home and commercial roof PV generation system and distributed PV generation system. Generally, the system consists of PV arrays, PV Grid-Connected Inverter and power distribution system, as shown in Figure2-1.



Figure2-1 Compose of PV generation system

2.1.1 Model Meaning

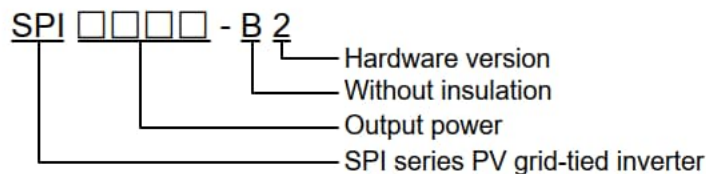

Figure2-2 Model meaning illustration

As shown in Figure2-2, **SPI** means that the product is Kehua's SPI series PV Grid-Connected Inverter, □□□□ means the output power of the inverter, when it is 5000, it means the output power is 5000VA, **B** means the inverter is without isolation, **2** means that the inverter is the second version.

2.1.2 Product Features

- Efficiently power generation: adopt efficient HERIC inverter topology and advanced completely digitized control technology.

- Safe and reliable: adopt aluminium alloy to diecast the outer case, so that the inverter can work in a widely temperature range.
- Smart manage: smart cloud platform monitor and APP monitor. The inverter supports RS485, GPRS and WIFI communication, and can be updated online.
- Green and friendly: small size, easy installation and use, air cooling, low noise.
- Better adaptability: with better grid adaptability, wide reactive power adjusting range.

2.2 Appearance and Structure

The appearance of the inverter is as shown in Figure2-3.

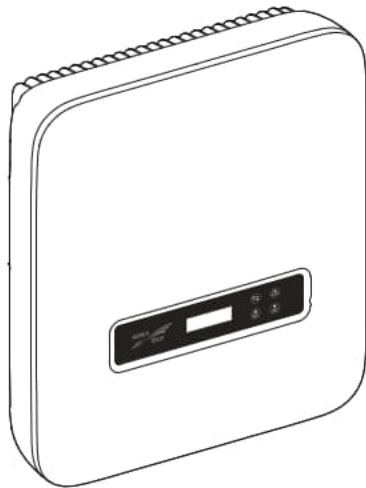

Figure2-3 Appearance of the inverter

2.2.1 Operation Panel

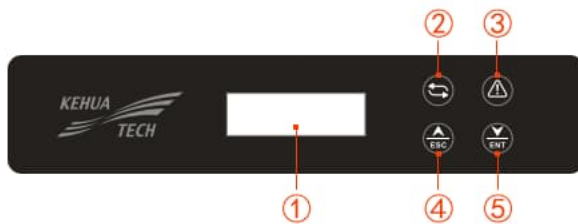

Figure2-4 Operation panel

Table2-1 Illustration of the operation panel

NO	Mark	Illustration	Remarks
①	-	LCD	<ul style="list-style-type: none"> ● Shows the inverter status and information. ● Shows the service and operation information

NO	Mark	Illustration	Remarks
			<ul style="list-style-type: none"> ● Shows the alarm information and fault.
②		Power indicator (green)	On: inverter is in grid-connected status. Flicker: PV power is normal
③		Alarm indicator (red)	On: inverter fault. Off: there is no fault.
④		ESC button	Short press: move the cursor upward or increase the setting value. Long press: back to previous menu or cancel the current command.
⑤		ENT button	Short press: move the cursor downward or decrease the setting value. Long press: enter sub menu or confirm the current command.

NOTE

Short press: less than 1s, Long press: more than 1s.

2.2.2 External Terminal Illustration

The external terminals are all located in the bottom of the inverter, including PV input, AC output, communication port and DC switch, etc, as shown in Figure2-5.

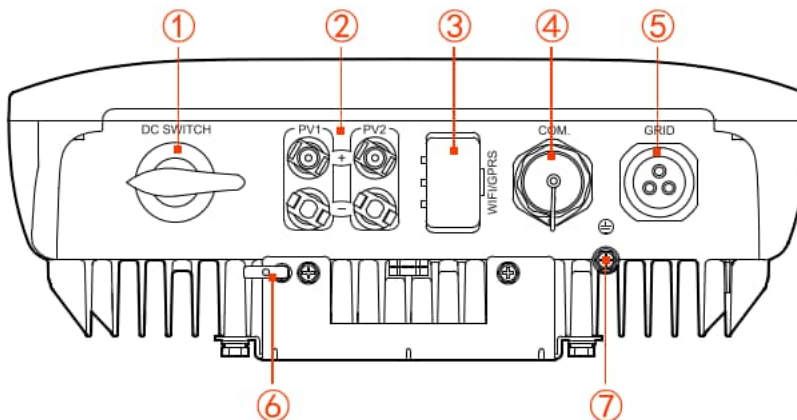



Figure2-5 Bottom view

Table2-2 Terminals illustration

NO.	Mark	Illustration	Remarks
①	DC SWITCH	DC transform switch	Optional
②	PV	DC input terminal	For SPI1500-B2 and SPI2000-B2, there are 2 DC terminals, for other models, there are 4 terminals
③	WIFI/GPRS	WIFI/GPRS port	It is used to monitor the running status of the inverter.
④	COM.	Connect with DRM, METER	Optional
⑤	GRID	AC output terminal	It is used to connect with grid.
⑥	-	Lock	It needs to provide by user.
⑦		Grounding port	External grounding port

NOTE

When the DC SWITCH and COM. is not selected, the corresponding port is filled with a waterproof plug.

DC switch

DC switch (as shown in Figure2-5 ①) is the connection switch of inverter and PV array. When the inverter works normally, the DC switch must be ON. During installation and wiring, the DC switch must be OFF. Before maintenance, the DC switch must be OFF for 20 minutes, and measure the voltage of DC busbar by multimeter, only when the voltage less than 10V, the maintenance can be done.

**CAUTION**

when maintenance or wiring, the DC switch must be disconnected.

2.3 Work Principle

The inverter connects with PV array input and tracks the maximum power point of the PV array, and then converts the DC power into single-phase AC power by inverter circuit. It also provides surge protection at DC and AC side, as shown in Figure 2-6, Figure 2-7.

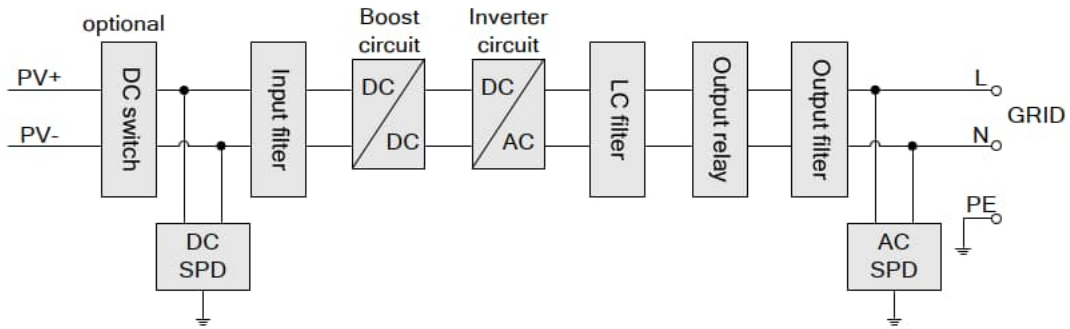

Figure 2-6 Work principle diagram of SPI1500-B2, SPI2000-B2

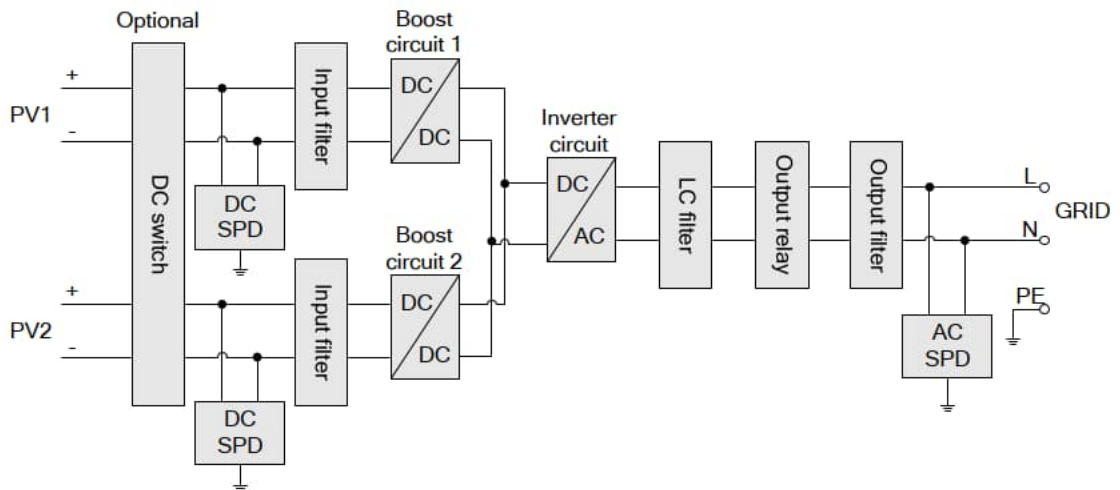

Figure 2-7 Work principle diagram of SPI3000-B2, SPI3600-B2, SPI4000-B2, SPI4600-B2, SPI5000-B2, SPI6000-B2

3 Installation Guide

This chapter introduces the installation of the inverter, including installation process, installation preparation, transportation and unpacking, installation procedure, electrical connection and checking, etc.

3.1 Installation Process

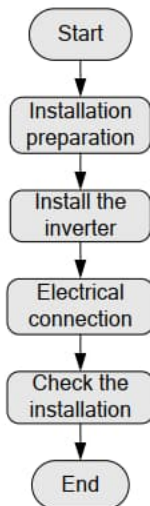



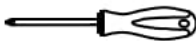



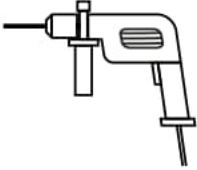

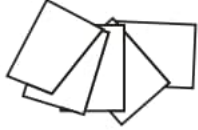

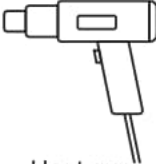
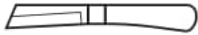

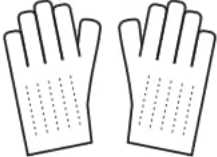
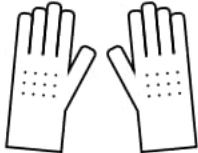



Figure3-1 Installation process

3.2 Installation Preparation

3.2.1 Tools

Tools			
			
Clamp meter	Multi-meter	Label paper	Phillips screwdriver

Tools			
 COAX crimping tool	 Diagonal pliers	 Wire stripper	 Claw hammer
 Hammer drill	 Insulation tape	 Cotton cloth	 Brush
 Heat shrink tubing	 Heat gun	 Electrician's knife	 Protective gloves
 ESD gloves	 Insulated gloves	 Hydraulic pliers	 Cable tie



CAUTION

The installation tools must be insulated to avoid electric shock.

3.2.2 Installation Environment

- Do not install the inverter in the place with poor ventilation.
- Ensure that there has sufficient fresh-air supply around the inverter.
- To ensure long service life and stable operation, avoid direct sunshine, rain or snow on the inverter. It is recommended to install the inverter in the place where has cover, as shown in Figure3-2.

- Recommended installation direction: do not install the inverter under directly sunshine. The countries in southern hemisphere (such as Australia, New Zealand) cannot install the inverter towards north, the countries in northern hemisphere (such as the Netherlands, Spain) cannot install the inverter towards south.

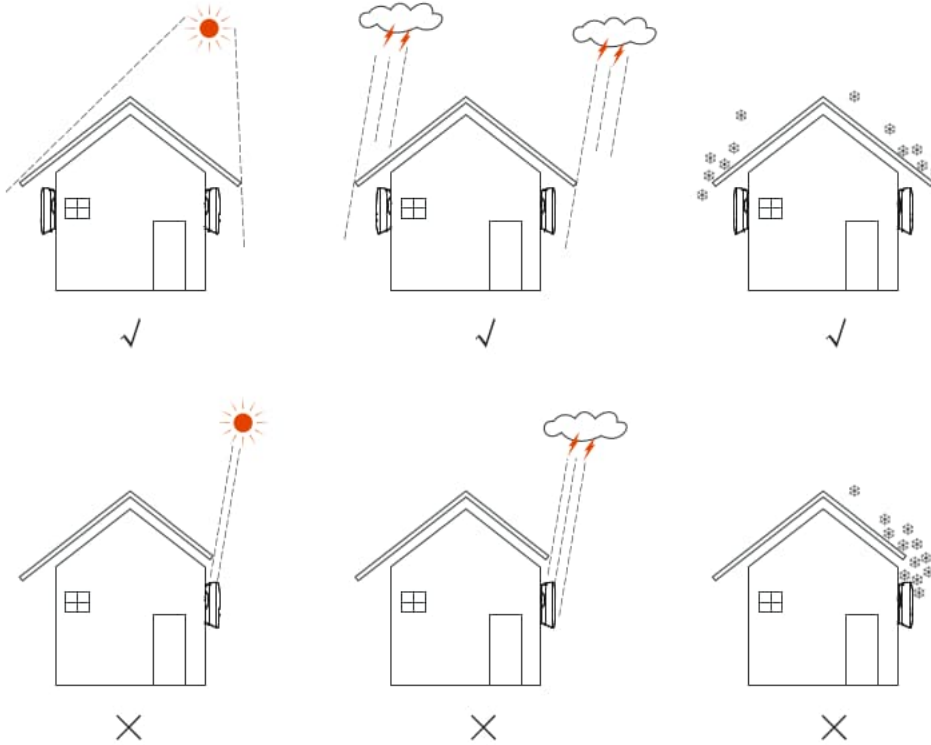

Figure3-2 Recommended installation site

- The inverter must be installed on the wall or supporter with enough bearing capacity.
- Consider the visibility of indicators and LCD.

3.2.3 Installation Space

Keep at least 500mm from the left and right side of the inverter to other objects or inverters, keep at least 600mm from the top of the inverter to ceiling and keep at least 600mm from bottom of the inverter to ground, which is good for heat dissipation or maintenance, as shown in Figure3-3.

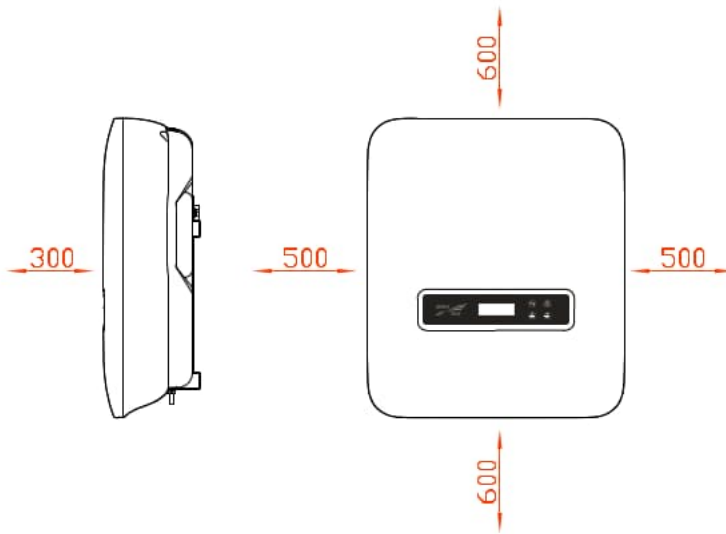

Figure3-3 Installation space (unit: mm)

3.2.4 Installation Way

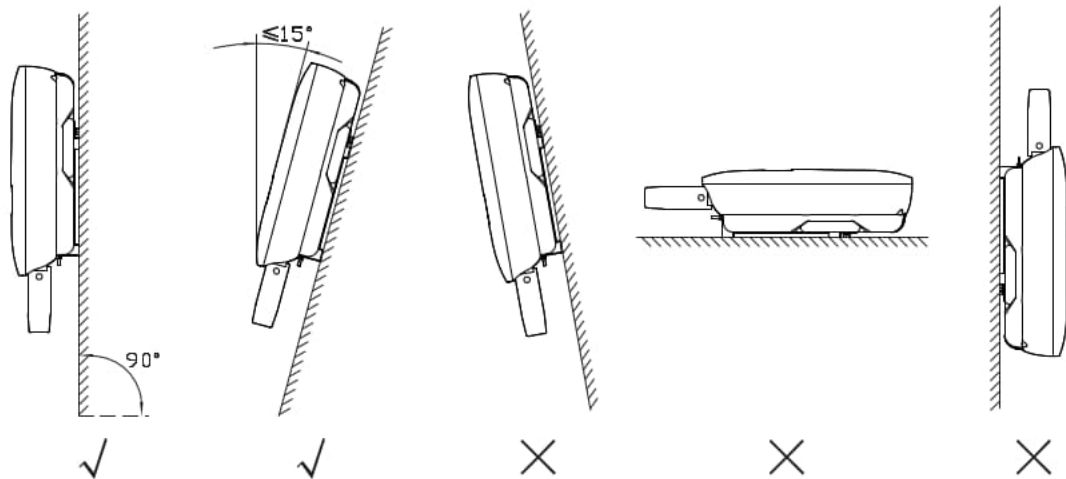

Figure3-4 Installation way

3.3 Transportation and unpacking

3.3.1 Transportation

The inverter should be transported by trained professional.



CAUTION

During transporting, please take care and avoid impacting or dropping.

3.3.2 Unpacking and Checking

 **NOTE**

Select the unpacking site in advance. In principle, the unpacking site should be as close to the installation site as possible.

The inverter has been tested and checked strictly, but it still may be damaged during transporting, so, please check it carefully.

- Inspect the inverter's appearance, if any shipping damage is found, report it to the carrier and your local dealer immediately.
- Check if the types of the accessories are complete and correct. If there is any discrepancy, take notes and contact the distributor immediately.



CAUTION

If the inverter needs to be stored for a long time after unpacking, it is necessary to pack the inverter by original package and save properly.

3.4 Installation

The inverter can be installed on the wall or metal holder through equipped installation holder.



CAUTION

Vertical installation is perfect. If it should be tilt, the vertical gradient should not exceed $\pm 15^\circ$.

In this section, we take wall installation as example to illustrate, if you need to install the inverter on metal installation holder, please adjust the installation step correspondingly.

- Step 1 Determine the installation place based on the inverter size (as shown in Figure3-5) and installation space (as shown in **3.2.3 Installation Space**).

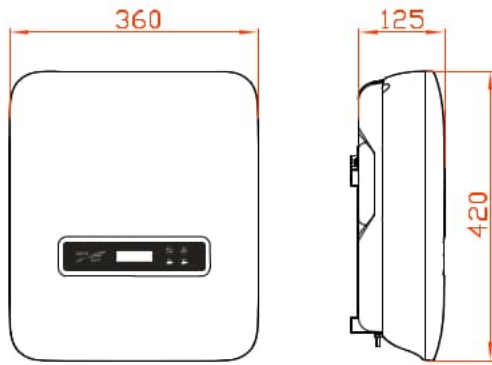

Figure3-5 Size (unit: mm)

- Step 2 Mark the position of installation holes on the wall according to the dimensions of the fixing holes of the installation holder (as shown in Figure3-6), and drill 4 holes of $\Phi 8.5\text{mm}$ on the wall according to marked position, as shown in Figure3-7

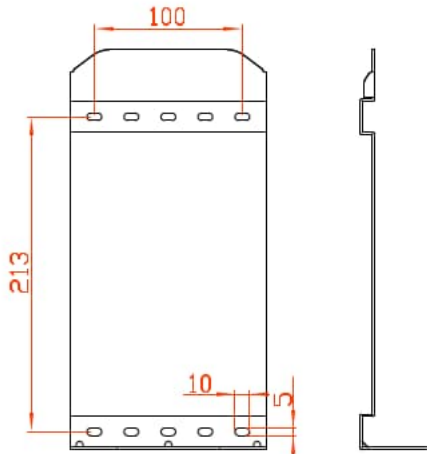

Figure3-6 Optimized installation size (unit: mm)



CAUTION

When installation, please keep the installation holder horizontal.

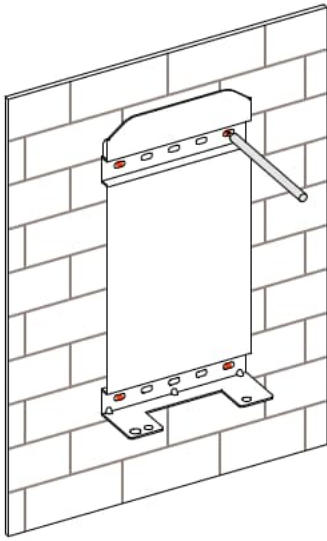

Figure3-7 Mark the drilling position



NOTE

The depth of drilled holes should be within 45~55mm. Clear the dust and measure the net depth. Ensure that the depth of four holes is the same.

Step 3 Install the equipped 4 expansion plugs into the holes, as shown in Figure3-8.

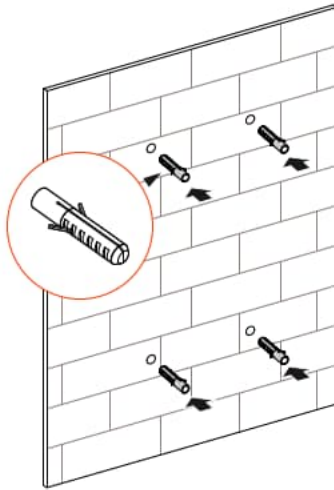

Figure3-8 Install expansion plugs

Step 4 Align the holes of installation holder with the expansion plugs and install the self-tapping screws and flat gasket into the expansion plugs (as shown in Figure3-9) and fasten them by screwdriver.

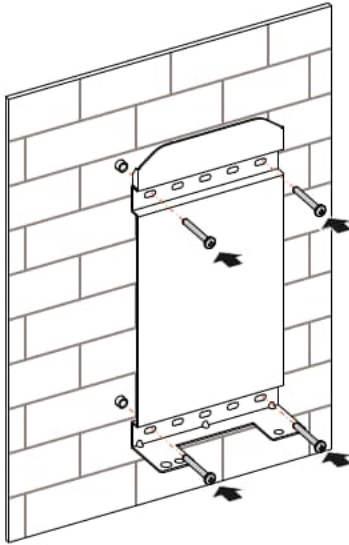

Figure3-9 Fasten the installation holder

Step 5 Uplift the inverter and hang the inverter to the installation holder, as shown in Figure3-10.

**CAUTION**

Do not loosen the inverter until the inverter has been hang in the installation holder completely.

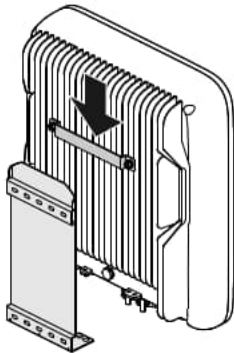

Figure3-10 Hang the inverter to installation holder

Step 6 Fasten the inverter to the installation holder by 2 stainless steel combination bolt M5*12 (as shown in Figure3-11), and then lock it. The lock position is as shown in Figure3-12.

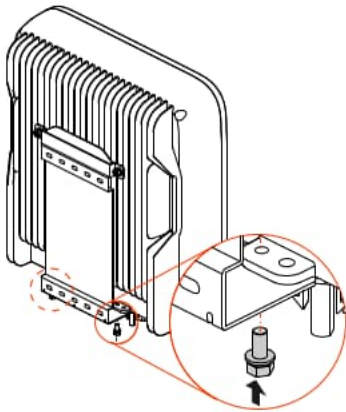

Figure3-11 Fasten the inverter

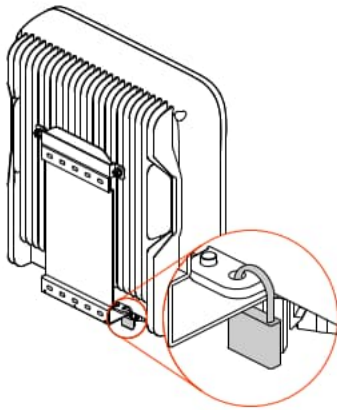

Figure3-12 Position of lock

—End

3.5 Electrical Connection

3.5.1 Wire Requirement

The wiring of the inverter is all at the bottom, as shown in Figure2-5 and Table2-2. The corresponding recommended wire specification as shown in Table3-1.

Table3-1 Wire specification

Type	Specification
DC input (PV)	4 mm ² ~ 6 mm ²
AC output (GRID)	4 mm ² ~ 6 mm ² (L/N/PE)
Grounding wire	4 mm ² ~ 6 mm ²

3.5.2 External Grounding Connection

The external grounding terminal is as shown in Figure2-5 ⑦.



WARNING

The external grounding wire cannot replace the PE wire of AC output terminal, they must be connected with ground reliably.

- Step 1 Strip the insulation layer of grounding wire for about 7mm, insert the wire into OT terminal and crimp them by crimping tool, the as shown in Figure3-13.

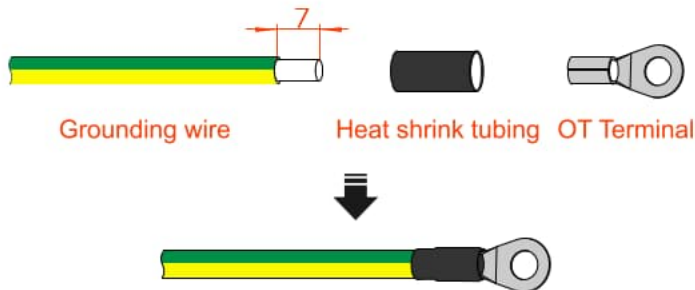

Figure3-13 Stripping diagram of external grounding wire (unit: mm)

- Step 2 Connect the crimped grounding wire to the external grounding terminal, as shown in Figure3-14.

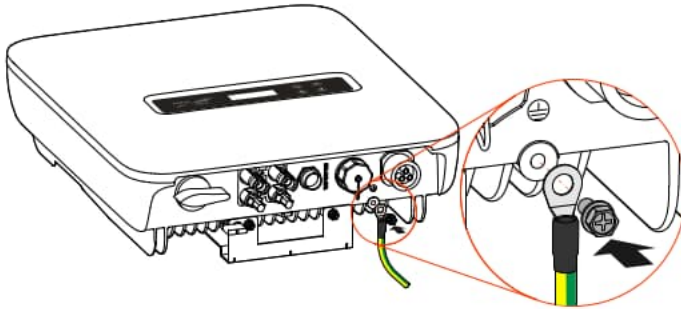

Figure3-14 External grounding wire connection

—End

3.5.3 DC Input (PV) Connection



CAUTION

- When installation, it must use the equipped DC terminals to avoid inverter damage.
- It is recommended to use independent breaker for each PV input, and before connecting, the breakers must be off. We suggest to use the special DC breaker (rated voltage is 600V, rated current is more than 20A).
- Switch off the DC switch and external DC breakers before connecting the PV array.
- Ensure that the connection between PV array and the inverter at positive pole and negative pole is correctly.
- The DC input voltage should be less than the max. input voltage of the inverter.
- It's forbidden to connect the grounding wire with positive pole or negative pole of PV array, or it will lead to inverter damage.

Use the equipped PV connector and metal terminal to connect the PV input. The PV connector includes positive connector and negative connector, they match the corresponding positive metal terminal and negative terminal, corresponding procedure as follows.

- Step 1 Strip the insulation layer of positive wire and negative wire for about 7mm, as shown in Figure3-15.



Figure3-15 Stripping diagram of DC input (unit: mm)

NOTE

It is recommended to use red wire as the positive wire, use black wire as negative wire to avoid wrong connection. If using the wires of other colour, please confirm the corresponding connection relationship.

- Step 2 Unscrew the lock nut of positive and negative connection, lead the positive and negative wires go through corresponding lock nut, and then insert the positive wire and negative wire into the positive metal terminal and negative metal terminal respectively. Crimp the metal terminals firmly by crimping pliers, as shown in Figure3-16.

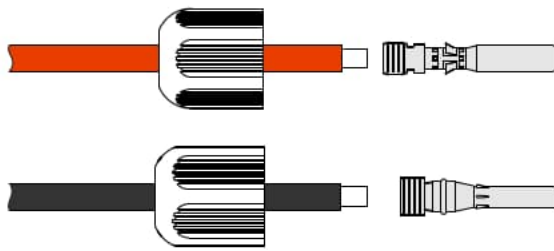

Figure3-16 Crimp the metal terminal

- Step 3 Insert the positive wire and negative wire into corresponding insulation crust respectively. If there has a click sound, it means that the wire have been inserted properly, as shown in Figure3-17.

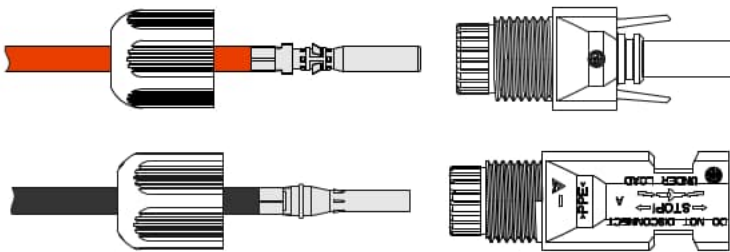

Figure3-17 Fasten the metal terminal

- Step 4 Tighten the sealing nuts of positive connector and negative connector to the corresponding insulation crusts respectively, as shown in Figure3-18.

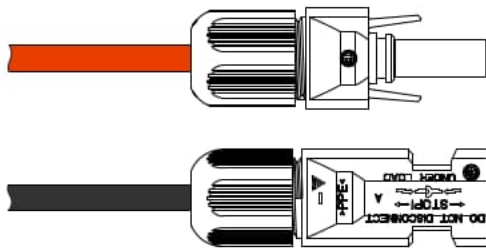

Figure3-18 Tighten the sealing nuts

- Step 5 Measure the voltage and check if the positive and negative is connected properly and if the voltage within the input range of the inverter.
- Step 6 Insert the positive connector and negative connector to the PV + and PV – terminals (as shown in Figure3-19) and tighten them. If there has a click sound, it means that the connector have been inserted properly.

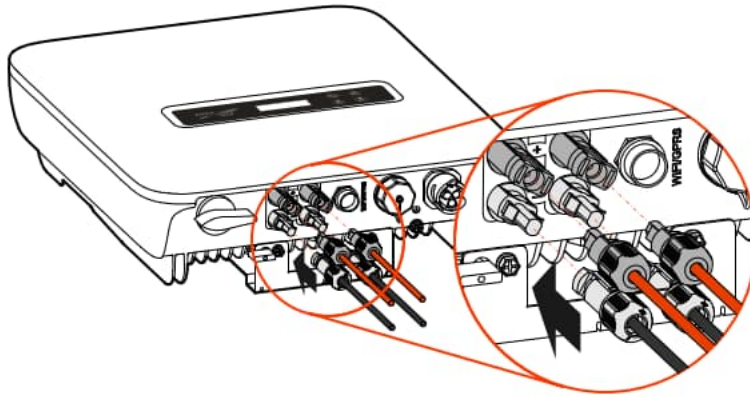

Figure3-19 Connect the DC connector

—End

3.5.4 AC Output (GRID) Connection



CAUTION

It's forbidden that several inverters shares an AC switch.

It's forbidden to connect with load between inverter and AC switch.

To ensure the inverter can be disconnected with load safely, we suggest equipping independent dipolar breaker for each inverter to protect the inverter.

Table3-2 Recommended AC breaker specification

Model	Specification
SPI1500-B2	20A
SPI2000-B2	20A
SPI3000-B2	25A
SPI3600-B2	25A
SPI4000-B2	32A
SPI4600-B2	32A
SPI5000-B2	32A

Model	Specification
SPI6000-B2	40A



CAUTION

During wiring, please pay attention to distinguish the AC live wire, neutral wire and grounding wire.

- Step 1 Strip the insulation layer of AC live wire (L), neutral wire (N) and grounding wire (PE) for about 7mm, as shown in Figure3-20.



Figure3-20 Stripping diagram of AC output (unit: mm)



NOTE

It is recommended to use red wire as the live wire, use blue wire as neutral wire and use yellow-green wire as PE wire to avoid wrong connection. If using the wires of other color, please confirm the corresponding connection relationship.

- Step 2 Unscrew the lock nut and waterproof of AC connector (as shown in Figure3-21), lead the live wire, neutral wire and grounding wire go through the lock and crimp them to corresponding port of AC connector.



NOTE

When crimping the wires, please ensure the live wire, neutral wire and PE wire are connected to the corresponding port of AC connector.

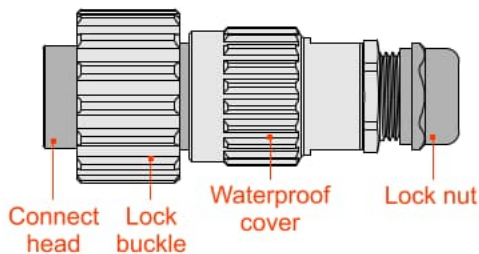

Figure3-21 AC connector

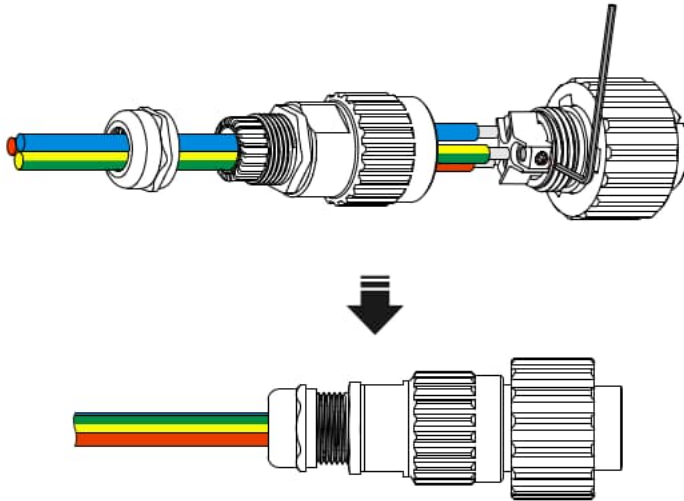

Figure3-22 Connect the wires of AC connector

**CAUTION**

There is L, N, PE mark on the AC connector, the wire connection must be accord with the mark correspondingly.

Step 3 Insert the AC connector to the GRID port (as shown in Figure3-23) and lock it.

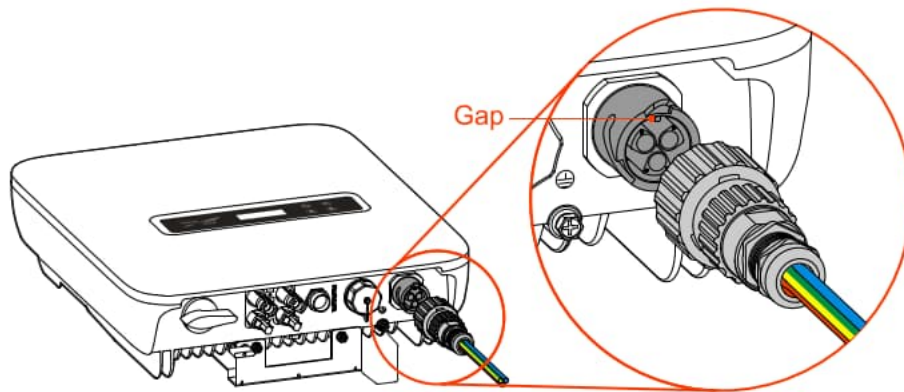

Figure3-23 Insert the AC connector

**CAUTION**

When inserting the AC connector, please pay attention to the gap on the AC connector and make it align the heave on the GRID port, avoid damaging the connector.

—End

3.5.5 WIFI/GPRS Connection

If the inverter is equipped with WIFI/GPRS, insert it to the WIFI/GPRS port (as shown in Figure3-24) to monitor on the internet. The monitor way is as shown in Figure3-25.

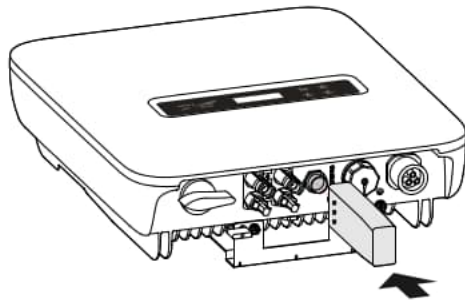

Figure3-24 WIFI/GPRS communication connection



NOTE

The GPRS do not need to set.

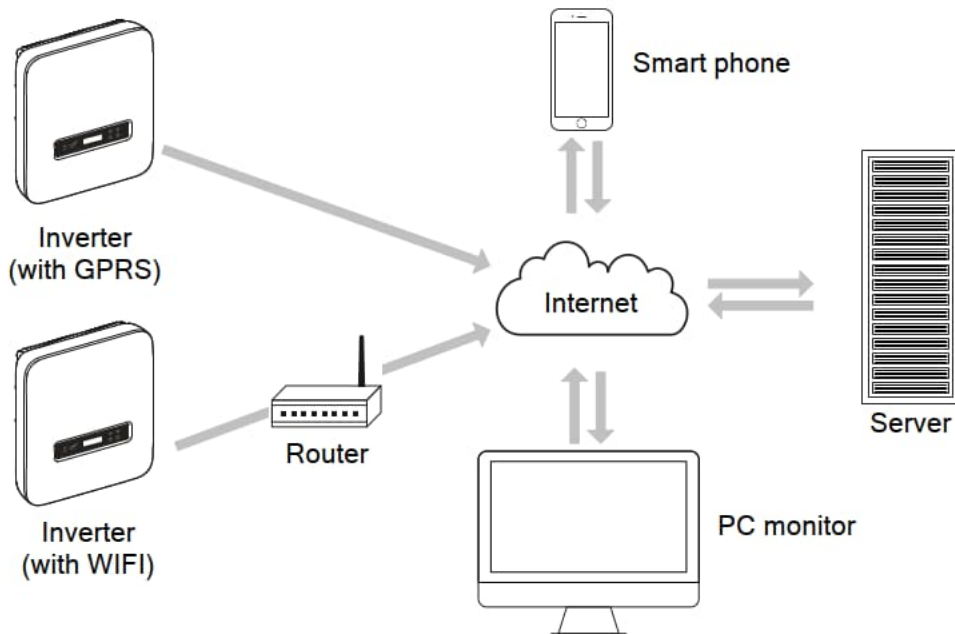

Figure3-25 WIFI/GPRS monitor way

3.5.6 Communication Port Connection (Optional)

COM. port can set to DRM and RS485 communication port, they all adopt RJ45 plug to connect. The pin definition of RJ45 plug is as shown in Figure3-26.

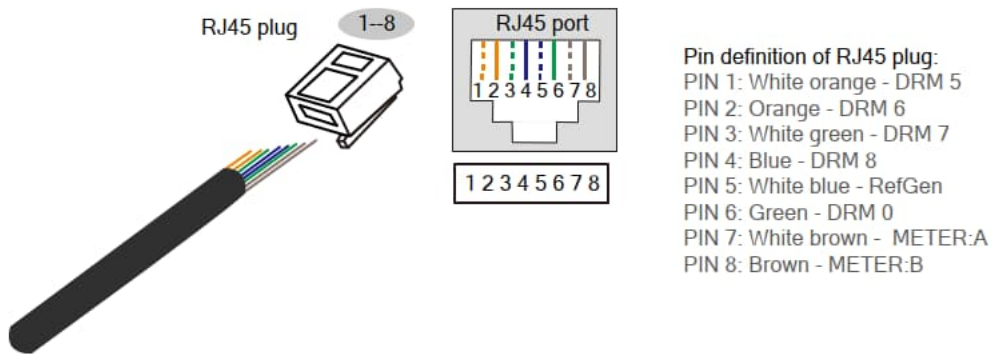

Figure3-26 Pin definition of inverter’s RJ45 plug

DRM port

DRM is used to connect the DRM controlling device.



CAUTION

When the COM. port set to DRM port, the PIN7 and PIN8 of inverter’s RJ45 plug cannot connect wires. The PIN7 and PIN8 of external DRM adapter’s RJ45 plug must be short connected together.

RS485 communication port

RS485 communication port is used to communicate with smart meter to achieve anti-countercurrent.

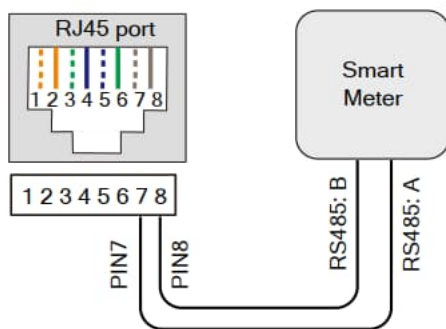

Figure3-27 Connection diagram between communication port and smart meter

NOTE

When using the anti-countercurrent function, the following setting must be done:

1. Set the anti-countercurrent enable in "System Setting-General Setting-I/O set" to open;
2. Set the anti-countercurrent power in "System Setting-General Setting-Engineer set" according to the actual use (the setting value of anti-countercurrent power is percentage, it is corrected by rated power. For example, when the rated power of the inverter is 5kW, if the anti-countercurrent power set to 30%, the set anti-countercurrent power is 1.5kW).

The communication procedure of COM. port is as follows.

- Step 1 Strip the insulation layer of communication wire, unscrew the lock nut of waterproof RJ45 port (as shown in Figure3-28) and then lead the communication wire go through the RJ45 port and crimp it to the RJ45 plug..

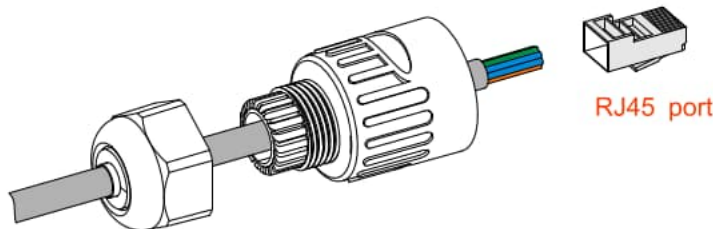

Figure3-28 Crimp the wires of RJ45 port

- Step 2 After crimping, insert the RJ45 plug into the buckle (as shown in Figure3-29), and then, screw the RJ45 port.

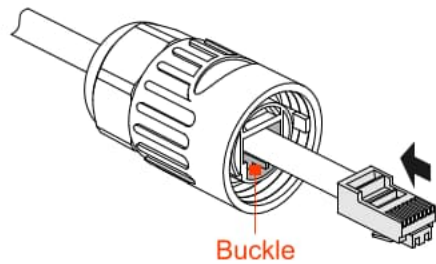

Figure3-29 Buckle position

- Step 3 Screw the waterproof cover on the COM. port, insert the RJ45 port to the COM. Port (as shown in Figure3-30) and screw it.

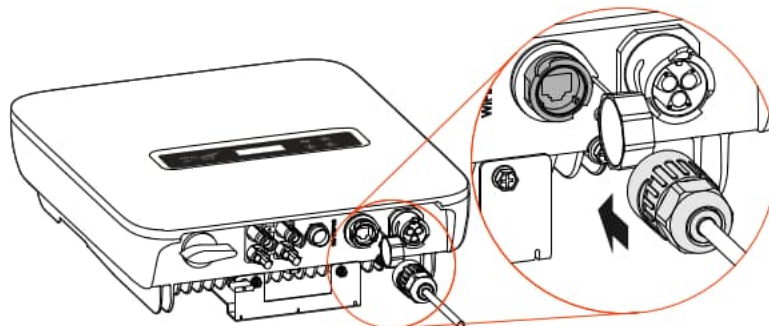

Figure3-30 Insert the communication port

—End

3.6 Check the Installation

After installation, check the following items:

- Check if the connection of DC input, AC output and communication wire are right.
- Check if the inverter is installed firmly.
- Check if all the screws of wiring are tightened.

4 LCD Operation

This chapter introduces the operation of LCD.

4.1 First Startup

When first power on, it will enter the power-on password page, as shown in Figure4-1. The corresponding button function is as shown in Table4-1. After entering the right password, it will show the main page.

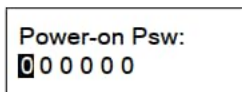



Figure4-1 Power-on password page

Table4-1 Button function on power-on password page

Button	Function
 ESC	<ul style="list-style-type: none"> ● Short press: add the number value ● Long press: clear enter value, the cursor back to the first position
 ENT	<ul style="list-style-type: none"> ● Short press: reduce the number value ● Long press: confirm the current entering, and the cursor move to right

4.2 Main Page

Main page can show date & time, inverter status, as shown in Figure4-2. When the inverter is grid-connected, the main page will show the daily power, gross power and output power circularly, as shown in Figure4-3 to Figure4-5. The corresponding button function is as shown in Table4-2

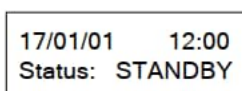

Figure4-2 Main page

```

17/01/01  12:00
E_daily  000.0kWh

```

Figure4-3 Grid-connected main page (1)

```

17/01/01  12:00
E total  000.0kWh

```

Figure4-4 Grid-connected main page (2)

```

17/01/01  12:00
P out    0.00kW

```

Figure4-5 Grid-connected main page (3)

Table4-2 Button function on main page

Button	Function
 ENT	Long press: enter main menu

4.3 Main Menu Page

There are 5 sub-menu, including running information, power query, record query, system setting and system information, as shown in Figure4-6 to Figure4-8, corresponding button function is as shown in Table4-3.

```

> Running Info  △
Power Query    ▽

```

Figure4-6 Function selection page (1)

```

> Record Query △
System Set     ▽

```

Figure4-7 Function selection page (2)



```

> System Info  △
Running Info   ▽

```

Figure4-8 Function selection page (3)

Table4-3 Button function on function selection page

Button	Function
	<ul style="list-style-type: none"> ● Short press: move the cursor upward ● Long press: back to main page
	<ul style="list-style-type: none"> ● Short press: move the cursor downward ● Long press: enter sub-menu

4.3.1 Running Information

In main menu page, select **Running Info**, the LCD will show the running information, as shown in Figure4-9 to Figure4-13, corresponding button function is as shown inTable4-4.

P_in	00.0kW△
P_out	00.0kW▽

Figure4-9 Running information page (1)

Freq	00.0Hz△
Volt	000.0V▽

Figure4-10 Running information page (2)

Curr	000.0A△
PV1_U	000.0V▽

Figure4-11 Running information page (3)



PV1_I	000.0A△
PV2_U	000.0V▽

Figure4-12 Running information page (4)

PV2_I	000.0A△
Temp	00°C▽

Figure4-13 Running information page (5)

Table4-4 Button function on running information page

Button	Function
	<ul style="list-style-type: none"> ● Short press: move the cursor upward ● Long press: back to main menu page
	<ul style="list-style-type: none"> ● Short press: move the cursor downward

4.3.2 Power Query

In main menu page, select **Power Query**, the LCD will show the power query page. In this page, it shows the daily power and total power, as shown in Figure4-14, corresponding button function is as shown in Table4-5.

E_daily	000.0kWh
E_total	000.0kWh

Figure4-14 Power query page

Table4-5 Button function on power query page

Button	Function
	Long press: back to main menu page

4.3.3 Record Query

In main menu page, select **Record Query**, the LCD will show the record query page. In this page, it shows the current fault, history fault, user log, grid-connected and off-grid record, as shown in Figure4-15 to Figure4-16. Long press  button, it will turn to detail info of selected item, as shown in Figure4-17 to Figure4-20, corresponding button function is as shown in Table4-8.

> Curr Fault	
Hist Fault	

Figure4-15 Record query page (1)



> User Log	
Hist Grid	

Figure4-16 Record query page (2)

```
17/01/01 001:
12:00:00 E001_1
```

Figure4-17 Current fault page

```
17/01/01 001:
12:00:00 E001_1
```

Figure4-18 History fault page



NOTE

Detailed fault info and dispose method please see Table6-1.

```
17/01/01 001:
12:00:00 U5010
```

Figure4-19 User log page

Table4-6 Corresponding list of user log code and information

User log code	User log information
U5000	ON/OFF setting
U5004	Anti-countercurrent function setting
U5010	Initiative islanding enable setting
U6000	Power factor control setting
U6001	Reactive power control setting
U6003	MPPT disturbance step setting
U6201	Anti- countercurrent power setting
U6202	Grid active power setting
U6020	Change date & time



```
17/01/01 001:
12:00:00 G000_1
```

Figure4-20 Grid-connected and off-grid record page

Table4-7 Corresponding list of grid-connected and off-grid record code and information

Record code	Record information
G000	Grid-connected
G001	Off-grid

Table4-8 Button function on record query page

Button	Function
	<ul style="list-style-type: none"> ● Short press: move the cursor upward, or add the checked record No. ● Long press: back to previous menu page
	<ul style="list-style-type: none"> ● Short press: move the cursor downward, or reduce the checked record No. ● Long press: enter sub-menu

4.3.4 System Setting

In main menu page, select **System Setting**, it will enter user login page. Select user and enter password, it will enter the page of corresponding user authority.

User includes general user (User) and administrator (Admin), as shown in Figure4-21, corresponding button function is as shown in Table4-9.

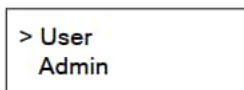



Figure4-21 Select user authority page

Table4-9 Button function on user authority selection page

Button	Function
	<ul style="list-style-type: none"> ● Short press: move the cursor upward ● Long press: back to main menu page
	<ul style="list-style-type: none"> ● Short press: move the cursor downward ● Long press: enter the cursor pointed user authority page



General user setting

The initial password of general user is 000111, as shown in Figure4-22, corresponding button function is as shown in Table4-10.



Figure4-22 Enter password page

Table4-10 Button function on login page

Button	Function
	<ul style="list-style-type: none"> ● Short press: add number value ● Long press: clear enter value, and back to user authority page
	<ul style="list-style-type: none"> ● Short press: reduce number value ● Long press: confirm the current entering, and the cursor move to right

The general user can set following items: date & time, language, ON/OFF, grid standards, power calibration, engineer setting, I/O set, clear history records, as shown in Figure4-23 to Figure4-30, corresponding button function is as shown in Table4-11.

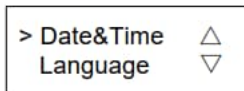

Figure4-23 General user setting page 1



Figure4-24 General user setting page 2

When the inverter is off, select **ON/OFF**, the LCD will enter the power-on confirmation page. When the inverter is on, the LCD will enter the power-off confirmation page, as shown in Figure4-25 and Figure4-26, corresponding button function is as shown in Table4-11.

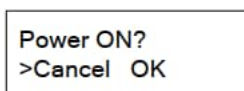

Figure4-25 Power-on confirmation page

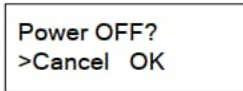

Figure4-26 Power-off confirmation page

NOTE

The grid standards includes Germany, England, China, Australia, New Zealand, France VDE, Italy, Netherlands, Spain, Thai PEA, Thai MEA, America, California, Canada, Country Grid, Urban Grid, France VFR, France SEI, France CASE, user etc.

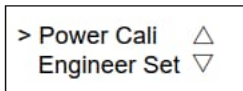

Figure4-27 General user setting page 3

NOTE

Engineer setting includes active power, reactive power, power factor, ISO protect, PV parallel mode, soft start, anti-countercurrent power, 10min voltage, overvoltage protection point, overvoltage recover point, under-voltage protection point, under-voltage recover point, over-frequency protection point, over-frequency recover point, under-frequency protection point, under-frequency recover point, PV mode setting, etc.

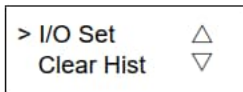

Figure4-28 General user setting page 4

NOTE

I/O set includes anti-island enable, anti-countercurrent enable, DRM mode.

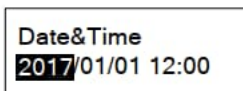

Figure4-29 Date & time setting page

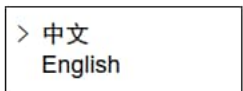



Figure4-30 Language setting page

Table4-11 Button function on user setting page

Button	Function
	● Short press: add number value or move the cursor upward

Button	Function
	<ul style="list-style-type: none"> ● Long press: back to previous menu page
	<ul style="list-style-type: none"> ● Short press: reduce number value or move the cursor downward ● Long press: enter the cursor pointed menu or confirm the current entering and the cursor move to right

Administrator setting

The administrator setting is for the manufacturer, the password must be generated by the product S/N.

4.3.5 System Information

In main menu page, select **System Info**, the LCD will show the system information, as shown in Figure4-31 to Figure4-36, corresponding button function is as shown in Table4-12.

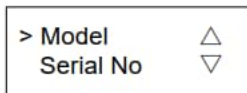

Figure4-31 System information (1)



Figure4-32 System information (2)

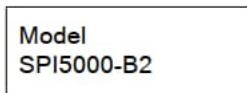

Figure4-33 Inverter model

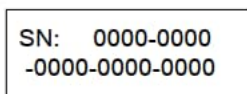

Figure4-34 S/N

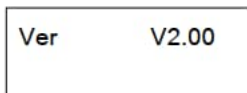



Figure4-35 Control software version



Figure4-36 Display software version

Table4-12 Button function on system information

Button	Function
 ESC	<ul style="list-style-type: none"> ● Short press: move the cursor upward ● Long press: back to previous menu
 ENT	<ul style="list-style-type: none"> ● Short press: move the cursor downward ● Long press: enter sub-menu

5 Startup and shutdown

This chapter introduces how to start and shut down the inverter.

5.1 Startup

- Step 1 Switch on the DC switch (optional) and DC switch in the project site. When the PV arrays provide enough startup voltage, the LCD will enter the main interface.
- Step 2 Switch on the AC switch between inverter and grid. If the alarm indicator doesn't light on, the LCD will show "current status: standby".
- Step 3 When the DC and AC supply power normally, the inverter will prepare to start. At first, the inverter will check the inner parameters and AC grid parameters, if they are in the normal range, 60s later, the inverter will check the insulation impedance.
- Step 4 About 60s, the inverter will generate power normally. The grid connection indicator will be on and the LCD will show: "current status: grid-connected".

—**End**

5.2 Shutdown

- Step 1 Switch off all switches.
- Step 2 Wait for all indicators off.

—**End**

6 Maintenance and Troubleshooting

This chapter mainly introduces the maintenance and troubleshooting for the inverter.

6.1 Maintenance

The inverter needn't to be maintained regularly, but the sundries or dust may influence the heat dissipation performance, so, use soft brush to clean the inverter. If the surface of LCD and LED indicator is too dirty to read, use a wet cloth to clean them.



HIGH TEMPERATURE

During running, do not touch the inverter. The temperature of some parts on the inverter is too high, and may cause scald injury. After shut down the inverter and wait until it cooling down, then do the maintenance and clean.



CAUTION

Do not clean the inverter with any solvent, abrasive material or corrosive material.

6.2 Troubleshooting

The inverter is designed on the basis of the grid-connected operation standards and meets the requirements of safety and EMC. Before provided to client, the inverter has been experienced for several rigorous tests to ensure reliable and optimizing operation.

If some faults occur, the display screen will show the corresponding alarm information. Under the circumstances, the inverter may stop power generation. The troubleshooting is as shown in Table6-1.

Table6-1 Troubleshooting

Code	Fault information	Solution
E016	Grid voltage abnormal	<ul style="list-style-type: none"> ● Check if the safety provision of the inverter meets the local grid-connected requirement. ● Check the local grid voltage. ● If they are all normal, please contact local distributor.
E017	Grid frequency abnormal	<ul style="list-style-type: none"> ● Check if the safety provision of the inverter meets the local grid-connected requirement. ● Check the local grid voltage. ● If they are all normal, please contact local distributor.
E025	PV1 over-voltage	Check the configuration of system battery board. If they are all normal, please contact local distributor.
E026	PV2 over-voltage	Check the configuration of system battery board. If they are all normal, please contact local distributor.
E027	Fan fault	If the fault always exists, please contact the local distributor.
E029	Inverter over-temperature	<ul style="list-style-type: none"> ● Check the radiator, and see if it is blocked. ● Check the environment temperature and see if the temperature exceeds the normal range. ● If they are all normal, please contact local distributor.
E032	Inverter over-current	If the fault always exists, please contact the local distributor.
E035	Grid current DC component abnormal	If the fault always exists, please contact the local distributor.
E038	Relay fault	If the fault always exists, please contact the local distributor.
E042	Leakage current protection	<ul style="list-style-type: none"> ● Check the insulation resistance of battery positive and negative. ● Check the environment and see if the environment is too moist. ● Check the grounding connection.

Code	Fault information	Solution
		<ul style="list-style-type: none"> ● If they are all normal, please contact local distributor.
E043	PV1 over-current	If the fault always exists, please contact the local distributor.
E044	PV2 over-current	If the fault always exists, please contact the local distributor.
E046	Radiator over-temperature	<ul style="list-style-type: none"> ● Check the radiator, and see if it is blocked ● Check the environment temperature and see if the temperature exceeds the normal range. ● If they are all normal, please contact local distributor.
E047	Insulation fault	<ul style="list-style-type: none"> ● Check the insulation resistance of battery positive and negative. ● Check the environment and see if the environment is too moist. ● Check the inner grounding and see if the connection is loose. ● If they are all normal, please contact local distributor.



CAUTION

If the inverter has any alarm information mentioned in Table6-1, please shut down the inverter(refer to **5.2 Shutdown**), 5 minutes later, restart the inverter (refer to **5.1 Startup**). If the alarm status is not removed, please contact our local dealer or service centre. Before contacting us, please prepare the following information.

1. Inverter S/N.
2. Distributor/ dealer of the inverter(if has).
3. The date of grid-connected power generation.
4. Problem description (that is the alarm information displayed on the display screen and the status of indicators and other information obtained from information menu (refer to **4.3.3 Record Query**)).
5. Your detail contact information.

7 Package, Transportation and Storage

This chapter introduces the package, transportation and storage of the inverter.

7.1 Package

The inverter is packaged by carton. When packaging, pay attention to the placing direction requirements. On the side of the carton, there has warning icons, including keep dry, handle with care, up, stacking layer limit, etc. On the other side of the carton, it prints the device model, etc. On the front side of the carton, there is the logo of Kehua company and device name.

7.2 Transportation

During transporting, pay attention to the warnings on the carton. DO NOT make the device impact severely. To avoid damaging the device, place the inverter strictly according to the placement direction. DO NOT carry the inverter with the objects that is inflammable, explosive, or corrosive. DO NOT put the inverter in the open-air while midway transshipment. Leaching or mechanical damage by rain, snow or liquid objects is prohibited.

7.3 Storage

During storage, place the inverter strictly according to the direction that showed on the carton. Keep at least 20cm from the bottom of the carton to floor and keep at least 50cm from the carton to wall, heat source, cold source, windows or air inlet.

The storage environment temperature is -40°C-70°C. After storing or transporting the inverter beyond the work temperature, keep the inverter aside and make its temperature return to normal range for more than 4h before installation. In warehouse, the poisonous gas, inflammable or explosive or corrosive chemical objects are prohibited. Besides, strong mechanical shaking, impact or strong magnetic field is also prohibited. Under the storage conditions above, the storage period is six months. If the inverter is stored beyond six months, it should be rechecked.

A Technical Specifications

Item \ Model	SPI1500 -B2	SPI2000 -B2	SPI3000 -B2	SPI3600 -B2	SPI4000 -B2	SPI4600 -B2	SPI5000 -B2	SPI6000 -B2
DC input								
Max. input power (W)	2025	2700	4050	4860	5400	6210	6750	8100
V _{max} PV (d.c.V)	600							
MPPT voltage range (d.c.V)	100~550							
I _{sc} PV (d.c.A)	16.5	16.5	2*13.8	2*13.8	2*13.8	2*13.8	2*13.8	2*13.8
Full-load MPPT voltage range (d.c.V)	125~450	165~450	150~450	180~450	200~450	230~450	250~450	300~450
Start voltage (d.c.V)	120							
MPPT route	1	1	2	2	2	2	2	2
Every route MPPT input string number	1	1	1/1	1/1	1/1	1/1	1/1	1/1
Max. input current (d.c.A)	13.2	13.2	11/11	11/11	11/11	11/11	11/11	11/11
Maximum inverter Backfeed Current to Array(A)	0	0	0	0	0	0	0	0
AC output								
Rated output power (W)	1500	2000	3000	3600	4000	4600	5000	6000
Max.apparent power (VA)	1650	2200	3300	3960	4400	5060	5500	6000

Item	Model	SPI1500	SPI2000	SPI3000	SPI3600	SPI4000	SPI4600	SPI5000	SPI6000
		-B2	-B2	-B2	-B2	-B2	-B2	-B2	-B2
Rated grid voltage (a.c.V)	230								
Grid voltage range (a.c.V)	195.5~253								
Grid type	Single-phase								
Rated output current (a.c.A)	6.8	9.2	13.6	16.4	18.2	20.9	22.7	27.3	
Max. Continuous output current(a.c.A)	6.8	9.2	13.6	16.4	18.2	20.9	22.7	27.3	
Inrush Current (peak and duration)	2.8A@12,1ms	3,0A@12,0ms	3,2A@12,2ms	3,7A@13,4ms	4,1A@12,4ms	3,8A@12,3ms	3,8A@12,3ms	4,4A@8,64ms	
Maximum Output Fault Current	105A@304 μ s	110A@314 μ s	122A@288 μ s	120A@330 μ s	180A@316 μ s	210A@298 μ s	312A@310 μ s	474A@303 μ s	
Maximum Output Over Current Protection(a.c.A)	20	23	25	32	32	32	32	40	
Rated grid frequency (Hz)	50/60								
Grid frequency range (Hz)	49.5~50.2								
Power factor (rated power)	>0.99								
Power factor adjusting range	0.8 ahead~0.8 lag(0.8* rated power)								
Output harmonic (rated condition)	<3%(test under rated power) <5%(load is 50%)								
DC component	<0.5%I _n								
Efficiency									
Max. efficiency	98.1%	98.1%	98.1%	98.3%	98.3%	98.3%	98.3%	98.3%	
Europe efficiency	97.7%	97.7%	97.7%	97.9%	97.9%	97.9%	97.9%	97.9%	
Protection									
DC reverse connection	Yes								

Item	Model	SPI1500	SPI2000	SPI3000	SPI3600	SPI4000	SPI4600	SPI5000	SPI6000
		-B2	-B2	-B2	-B2	-B2	-B2	-B2	-B2
protection									
Islanding protection	<2s								
Smart feed-in control	Yes (via smart meter)								
AC short-circuit protection	Yes								
Leakage current protection	Yes								
DC switch	Optional								
PV Fault Detect	Yes								
Input DC impedance monitor	Yes								
Surge protection	Piezoresistor								
Basic parameter									
Size (W×H×D) (mm)	360×420×125								
Weight (kg)	11.8(Max.)			12.6(Max.)					
Installation way	Wall-mounting								
Insulation way	No transformer								
Ingress protection	IP65								
Self-consumption at night	<1W								
Environment temperature range	-30~60℃ (If the temperature higher than 45℃ or lower than -25℃, the inverter needs to decrease rated power to use)								
Relative humidity	0~100%								
Cooling way	Air-cooling								
Altitude	3000m (If the altitude higher than 2000m, the inverter needs to decrease rated power to use)								
Noise	<25db @ 1m								

Item	Model	SPI1500	SPI2000	SPI3000	SPI3600	SPI4000	SPI4600	SPI5000	SPI6000
		-B2	-B2	-B2	-B2	-B2	-B2	-B2	-B2
Inverter design	Transformerless								
Display	LCD/LED/button								
Communication	RS485 /WIFI(optional)/GPRS(optional)								
AC terminal	Plug and play (max. 6mm ²)								
DC terminal	MC4(max. 6mm ²)								
Other function									
Whole machine	Update online								

- Specifications are subject to change without prior notice.

B Acronyms and Abbreviations

A

AC Alternating Current

D

DC Direct Current

L

LCD Liquid Crystal Display

LED Light-emitting Diode

M

MPPT Maximum Power Point Tracking

P

PE Protective Earthing

PV Photovoltaic

R

RS485 Recommend Standard485



XIAMEN KEHUA HENGSHENG CO., LTD.

4402-02440 004

ADD: No. 457, Malong Road, Torch High-Tech Industrial
Zone, Xiamen, Fujian, China(361000)
TEL: 0592-5160516(8 lines) FAX: 0592-5162166
Http: //www.kehua.com

Manufacturer: Zhangzhou Kehua Technology Co., Ltd.
ADD: Beidou Industrial Zone, Jinfeng Industrial District,
Zhangzhou, Fujian, China(363000)
TEL: 0596-2600000 2600886 FAX: 0596-2895827